

# ASTRO® XTS™ 3000

Digital Portable Radios

Basic Service Manual



**MOTOROLA**

*intelligence everywhere™*





# **XTS 3000 ASTRO Digital Radio Basic Service Manual**



### **Computer Software Copyrights**

The Motorola products described in this manual may include copyrighted Motorola computer programs stored in semiconductor memories or other media. Laws in the United States and other countries preserve for Motorola certain exclusive rights for copyrighted computer programs, including, but not limited to, the exclusive right to copy or reproduce in any form the copyrighted computer program. Accordingly, any copyrighted Motorola computer programs contained in the Motorola products described in this manual may not be copied, reproduced, modified, reverse-engineered, or distributed in any manner without the express written permission of Motorola. Furthermore, the purchase of Motorola products shall not be deemed to grant either directly or by implication, estoppel, or otherwise, any license under the copyrights, patents or patent applications of Motorola, except for the normal non-exclusive license to use that arises by operation of law in the sale of a product.

### **Document Copyrights**

No duplication or distribution of this document or any portion thereof shall take place without the express written permission of Motorola. No part of this manual may be reproduced, distributed, or transmitted in any form or by any means, electronic or mechanical, for any purpose without the express written permission of Motorola.

### **Disclaimer**

The information in this document is carefully examined, and is believed to be entirely reliable. However, no responsibility is assumed for inaccuracies. Furthermore, Motorola reserves the right to make changes to any products herein to improve readability, function, or design. Motorola does not assume any liability arising out of the applications or use of any product or circuit described herein; nor does it cover any license under its patent rights nor the rights of others.

### **Trademarks**

MOTOROLA and the Stylized M logo are registered in the US Patent & Trademark Office. All other product or service names are the property of their respective owners.

# Contents

## Chapter 1: Safety Information

1.1	1-1
-----	-----

## Chapter 2: Model Charts and Test Specifications

2.1 Specifications for VHF Radios	2-2
2.2 Specifications for UHF Radios	2-4
2.3 Specifications for 800 MHz Radios	2-7

## Chapter 3: Overview

3.1 Notations Used in This Manual	3-1
3.2 Radio Description	3-2
3.3 FLASHPort	3-3

## Chapter 4: Basic Maintenance

4.1 Preventive Maintenance	4-1
4.1.1 Inspection	4-1
4.1.2 Cleaning	4-1
4.1.2.1 Cleaning External Plastic Surfaces	4-2
4.2 Handling Precautions	4-2
4.2.1 XTS 3000 R Radios Only	4-2

## Chapter 5: Recommended Test Equipment and Service Aids

5.1 Recommended Test Equipment	5-1
5.2 Service Aids	5-2
5.3 Field Programming Equipment	5-3

## Chapter 6: Performance Checks

6.1 Setup	6-1
6.2 Test Mode	6-2
6.2.1 Entering Test Mode	6-2
6.2.2 RF Test Mode	6-3
6.2.3 Control Top and Keypad Test Mode	6-5

## Chapter 7: ALIGNMENT PROCEDURE

7.1 General	7-1
7.2 Reference Oscillator	7-4

7.2.1 Preventative Maintenance . . . . .	7-4
7.2.2 Reference Oscillator Alignment . . . . .	7-4
7.2.2.1 Initial Setup Using R-2670 and 8900 Series Analyzers . . . . .	7-5
7.3 Transmit Power Alignment . . . . .	7-7
7.3.1 RSS and CPS Procedures . . . . .	7-7
7.4 Transmit Deviation Balance (Compensation) Alignment . . . . .	7-8
7.4.1 RSS and CPS Procedures . . . . .	7-9
7.5 Transmit Deviation Limit Alignment . . . . .	7-10
7.5.1 RSS and CPS Procedures . . . . .	7-11
7.6 Front End Filter Alignment (VHF and UHF only) . . . . .	7-13
7.6.1 RSS and CPS Procedures . . . . .	7-14
7.7 Bit Error Rate Testing . . . . .	7-16

**Chapter 8: Basic Removal/Installation Procedures**

8.1 Antenna . . . . .	8-1
8.1.1 Installing the Antenna . . . . .	8-1
8.1.2 Removing the Antenna . . . . .	8-1
8.2 Battery . . . . .	8-2
8.2.1 Installing the Battery . . . . .	8-3
8.2.2 Removing the Battery . . . . .	8-3
8.3 Belt Clip . . . . .	8-4
8.3.1 Installing the Belt Clip . . . . .	8-4
8.3.2 Removing the Belt Clip . . . . .	8-5
8.4 Universal Connector Cover . . . . .	8-5
8.4.1 Installing the Universal Connector Cover . . . . .	8-6
8.4.2 Removing the Universal Connector Cover . . . . .	8-6
8.5 Frequency Knob . . . . .	8-7
8.5.1 Installing the Frequency Knob . . . . .	8-7
8.5.2 Removing the Frequency Knob . . . . .	8-8
8.6 Volume Knob . . . . .	8-8
8.6.1 Installing the Volume Knob . . . . .	8-9
8.6.2 Removing the Volume Knob . . . . .	8-9
8.7 Partial Exploded View and Parts List . . . . .	8-10

**Chapter 9: Theory of Operation**

9.1 General Overview . . . . .	9-1
9.2 Analog Mode of Operation . . . . .	9-2
9.3 ASTRO Mode of Operation . . . . .	9-2
9.4 RF Board Basic Theory of Operation . . . . .	9-3
9.5 Controller Board Basic Theory of Operation . . . . .	9-3
9.6 Vocoder Board Basic Theory of Operation . . . . .	9-4

**Chapter 10: Troubleshooting**

10.1 Power-Up Error Codes . . . . .	10-1
10.2 Operational Error Codes . . . . .	10-2

**Glossary**

# Safety Information

---

## Product Safety and RF Exposure Compliance



### CAUTION

**Before using this product, read the operating instructions for safe usage contained in the Product Safety and RF Exposure booklet enclosed with your radio.**

This radio is restricted to occupational use only to satisfy FCC RF energy exposure requirements. Before using this product, read the RF energy awareness information and operating instructions in the Product Safety and RF Exposure booklet enclosed with your radio (Motorola part number 6881095C98) to ensure compliance with RF energy exposure limits.

For a list of Motorola-approved antennas, batteries, and other accessories, visit the following website which lists approved accessories: <http://www.motorola.com/cgiss/index.shtml>.

## 1.1

---

**This page intentionally left blank.**



# Model Charts and Test Specifications

Figure 2-1 Portable Radio Model Numbering System

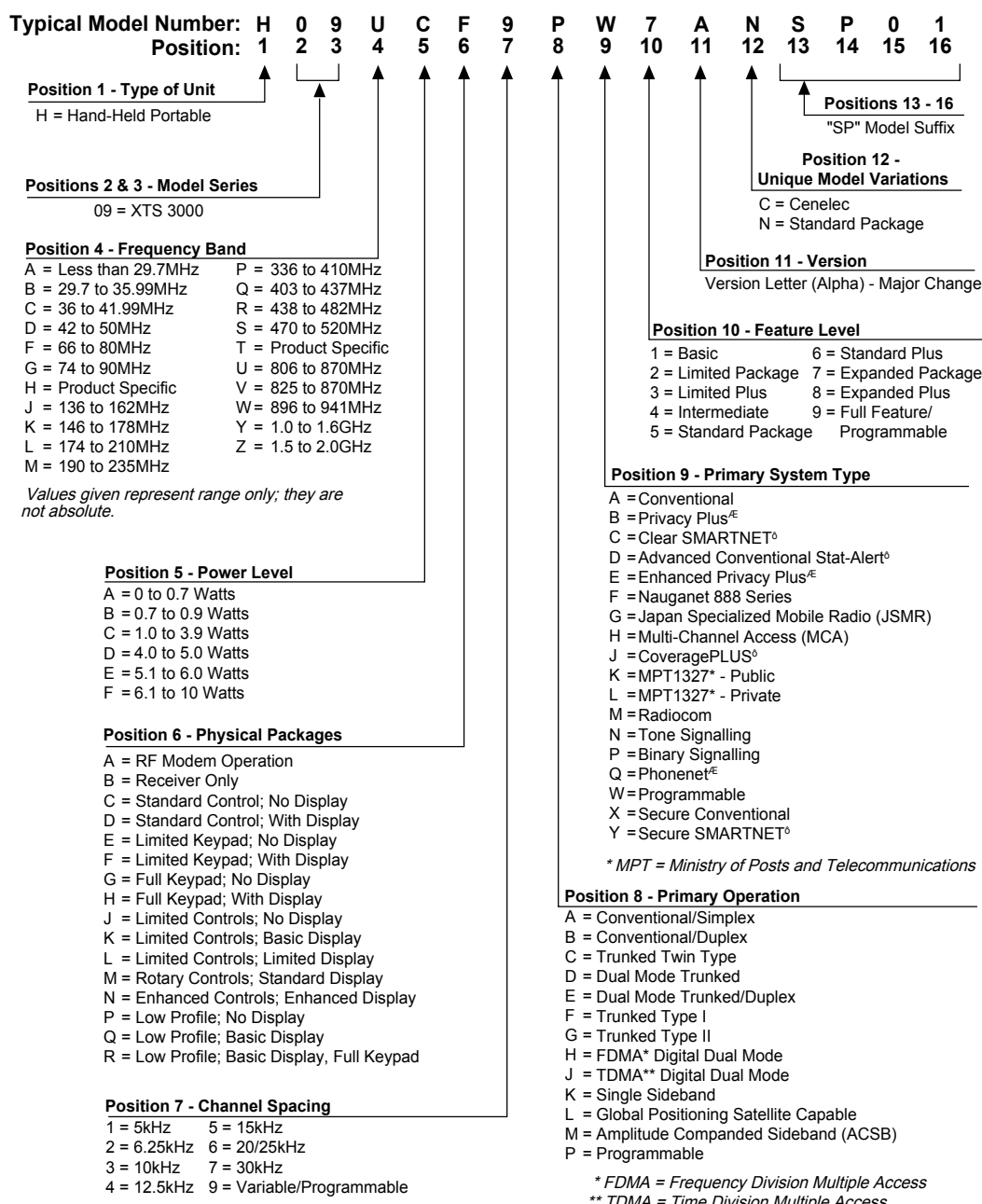

## 2.1 Specifications for VHF Radios

All specifications are per Electronic Industries Association (EIA) 316B unless otherwise noted.

**Table 2-1** General Specifications

General Specifications	
<b>FCC Designation:</b>	AZ489FT3790
<b>Temperature Range:</b>	
<b>Operating:</b>	-30° C to +60° C
<b>Storage:</b>	-40° C to +85° C
<b>Power Supply:</b>	
Nickel-Cadium Battery (NiCd) or Nickel-Metal-Hydride Battery (NiMH)	
<b>Battery Voltage:</b>	7.5 Volts
<b>Nominal:</b>	6 to 9 Volts
<b>Range:</b>	
<b>Transmit Current Drain (Typical):</b>	2300mA
<b>Receive Current Drain (Rated Audio):</b>	290mA
<b>Standby Current Drain:</b>	90mA
<b>Recommended Battery:</b>	
<b>Ultra-High-Capacity NiMH :</b>	NTN8294A
or <b>Ultra-High-Capacity NiCd FM:</b>	NTN8295*
or <b>Ultra-High Capacity NiMH FM:</b>	NTN8299A*
<b>Optional FM (Factory Mutual) Battery:</b>	
<ul style="list-style-type: none"> <li>* FM Intrinsically Safe: Class I, II, III, Division 1, Groups C, D,E, F, and G. FM Non-incendive: Class 1, Division 2, Groups A, B, C, and D.</li> </ul>	
<b>Dimensions (HxWxD):</b>	
 <span style="background-color: #0070c0; color: white; padding: 2px 5px; font-weight: bold;">NOTE</span>	
2.44" = width at PTT; 2.34" = width at bottom; 1.83" = depth at speaker; 0.97" = depth at keypad	
<b>Less Battery:</b>	
6.58" x 2.44" x 1.83"/6.58" x 2.34" x 0.97" (167.13mm x 61.90mm x 46.42mm/167.13mm x 59.49mm x 24.56)	
<b>With Battery:</b>	

**Table 2-1** General Specifications (Continued)

<b>General Specifications</b>	
6.58" x 2.44" x 1.83"/6.58" x 2.34" x .97" (167.13mm x 61.90mm x 46.42mm/167.13mm x 59.49 mm x 24.56 mm)	
<b>Weight: (w/Antenna):</b>	
<b>Less Battery:</b>	14.10 oz (383 gm)
<b>With Ultra-High Cap. NiMH:</b>	23.45 oz (644 gm)
<b>With Ultra-High Cap. NiCd:</b>	25.19 oz (693 gm)
* Specifications subject to change without notice.	

**Table 2-2** Receiver Specifications

<b>Receiver</b>	
<b>Frequency Range:</b>	136–178 MHz
<b>Bandwidth:</b>	42 MHz
Quieting Sensitivity (20dBQ):	0.35 $\mu$ V (typical)
<b>Usable Sensitivity (Typical) (12dB SINAD):</b>	0.25 $\mu$ V
<b>Intermodulation (Typical):</b>	—75 dB
<b>Selectivity (Typical)</b>	
<b>(25/30 kHz Adjacent Channel):</b>	—75dB
<b>Spurious Rejection:</b>	—70dB
<b>Frequency Stability</b>	
<b>(-30 to +60°C; 25°C reference):</b>	$\pm$ .0002%
<b>Rated Audio:</b>	500mW
<b>Distortion (At Rated Audio):</b>	2% Typical
<b>Channel Spacing:</b>	12.5/20/25/30 kHz
* Specifications subject to change without notice.	

**Table 2-3** Transmitter Specifications

<b>Transmitter</b>	
<b>RF Power:</b>	
<b>136–174 MHz:</b>	1 Watt/5 Watts
<b>174–178 MHz:</b>	1 Watt/4 Watts
<b>Frequency Range:</b>	136–178MHz
<b>Frequency Stability (typical)</b>	
<b>(-30 to +60°C; 25°C ref.):</b>	$\pm$ .0002%
<b>Emission (Conducted and Radiated):</b>	—70dBc

**Table 2-3** Transmitter Specifications (Continued)

Transmitter	
<b>FM Hum and Noise (typical)</b>	
<b>(Companion Receiver):</b>	25/30 kHz —48dB 12.5 kHz —42dB
<b>Distortion:</b>	2% Typical
<b>Modulation Limiting:</b>	25/20 kHz chnls ±5.0kHz 20 kHz chnls ±4.0 kHz 12.5kHz chnls ±2.5kHz
<b>Emissions Designators:</b>	
20K0F1E, 16K0F3E, 11K0F3E, 8K0F1D and 8K10F1E	
* Specifications subject to change without notice.	

## 2.2 Specifications for UHF Radios

All specifications are per Electronic Industries Association (EIA) 316B unless otherwise noted.

**Table 2-4** General Specifications

General Specifications	
<b>FCC Designation:</b>	AZ489FT3804
<b>Temperature Range:</b>	
<b>Operating:</b>	—30°C to +60°C
<b>Storage:</b>	—40°C to +85°C
<b>Power Supply:</b>	
Nickel-Cadium Battery (NiCd) or Nickel-Metal-Hydride Battery (NiMH)	
<b>Battery Voltage:</b>	6 to 9 Volts
<b>Nominal:</b>	7.5 Volts
<b>Range:</b>	
<b>Transmit Current Drain (Typical):</b>	1700mA
<b>Receive Current Drain (Rated Audio):</b>	290mA
<b>Standby Current Drain:</b>	90mA
<b>Recommended Battery:</b>	

**Table 2-4** General Specifications (Continued)

General Specifications	
<b>Ultra-High-Capacity NiCd :</b>	NTN8294A
or <b>Ultra-High-Capacity NiCd FM:</b>	NTN8295*
or <b>Ultra-High-Capacity NiMH FM IS:</b>	NTN8299A*
<b>Optional FM (Factory Mutual) Battery:</b>	
<ul style="list-style-type: none"> <li>FM Intrinsically Safe: Class I, II, III, Division 1, Groups D, F, and G</li> </ul>	
<b>Dimensions (HxWxD):</b>	
 <div style="background-color: #00a0e3; color: white; padding: 2px 5px; display: inline-block; margin-left: 10px;"><b>NOTE</b></div>	
2.44" = width at PTT; 2.34" = width at bottom; 1.83" = depth at speaker; 0.97" = depth at keypad	
<b>Less Battery:</b>	
6.58" x 2.44" x 1.83"/6.58" x 2.34" x 0.97" (167.13mm x 61.90mm x 46.42mm/167.13mm x 59.49mm x 24.56)	
<b>With Ultra-High Capacity NiMH Battery:</b>	
6.58" x 2.44" x 1.83"/6.58" x 2.34" x 1.65" (167.13mm x 61.90mm x 46.42mm/167.13mm x 59.49 mm x 41.97 mm)	
<b>With Ultra-High Capacity NiCd Battery:</b>	
6.58" x 2.44" x 1.83"/6.58" x 2.34" x 1.65" (167.13mm x 61.90mm x 46.42mm/167.13mm x 59.49 mm x 41.97mm)	
<b>With Ultra-High Capacity NiCd Battery:</b>	
6.58" x 2.44" x 1.83"/6.58" x 2.34" x 1.65" (167.13mm x 61.90mm x 46.42mm/167.13mm x 59.49 mm x 41.97mm)	
<b>With Ultra-High Capacity NiCd Battery:</b>	
6.58" x 2.44" x 1.83"/6.58" x 2.34" x 1.65" (167.13mm x 61.90mm x 46.42mm/167.13mm x 59.49 mm x 41.97mm)	
<b>Weight: (w/Antenna):</b>	
<b>Less Battery:</b>	14.10 oz (383 gm)
<b>With Ultra-High Cap. NiMH:</b>	23.45 oz (644 gm)
<b>With Ultra-High Cap. NiCd:</b>	25.19 oz (693 gm)

**Table 2-4** General Specifications (Continued)

<b>General Specifications</b>	
<b>With NiMH FM IS:</b>	23.45 oz (644 gm)
* Specifications subject to change without notice.	

**Table 2-5** Receiver Specifications

<b>Receiver</b>	
<b>Frequency Range:</b>	403–520 MHz
<b>Bandwidth:</b>	70 MHz
<b>Quieting Sensitivity (typical) (20dBQ):</b>	0.35 $\mu$ V (typical)
<b>Usable Sensitivity (typical) (12dB SINAD):</b>	0.25 $\mu$ V (typical)
<b>Intermodulation (typical):</b>	—75dB (typical)
<b>Selectivity (typical)</b>	
<b>(25/30kHz Channel):</b>	—75dB
<b>(12.5kHz Channel):</b>	—60dB
<b>Spurious Rejection:</b>	—70dB
<b>Frequency Stability</b>	
<b>(-30 to +60°C; 25°C reference):</b>	$\pm$ .0002%
<b>Rated Audio:</b>	500mW
<b>Distortion (At Rated Audio):</b>	2% Typical
<b>Channel Spacing:</b>	12.5/20/25/25/30 kHz
* Specifications subject to change without notice.	

**Table 2-6** Transmitter Specifications

<b>Transmitter</b>	
<b>RF Power:</b>	
<b>403–470MHz:</b>	1 Watt/4 Watts
<b>450–520MHz:</b>	1 Watt/4 Watts
<b>Frequency Range:</b>	403–520 MHz
<b>Frequency Stability</b>	
<b>(-30 to +60°C; 25°C ref.):</b>	$\pm$ .0002%
<b>Emission (Conducted and Radiated):</b>	—70dBc
<b>FM Hum and Noise (typical)</b>	
<b>(Companion Receiver):</b>	25/30 kHz —43dB
	12.5 kHz —38dB
<b>Distortion:</b>	2% Typical

**Table 2-6** Transmitter Specifications (Continued)

Transmitter	
<b>Modulation Limiting:</b>	25/30 kHz chnls $\pm 5.0$ kHz
	20kHz chnls $\pm 4.0$ kHz
	12.5kHz chnls $\pm 2.5$ kHz
<b>Emissions Designators:</b>	
	20K0F1E, 16K0F3E, 11K0F3E, 15K0F1D and 8K10F1E
* Specifications subject to change without notice.	

## 2.3 Specifications for 800 MHz Radios

All specifications are per Electronic Industries Association (EIA) 316B unless otherwise noted.

**Table 2-7** General Specifications

General Specifications	
<b>FCC Designation:</b>	AZ489FT3804
<b>Temperature Range:</b>	
<b>Operating:</b>	$-30^{\circ}\text{C}$ to $+60^{\circ}\text{C}$
<b>Storage:</b>	$-40^{\circ}\text{C}$ to $+85^{\circ}\text{C}$
<b>Power Supply:</b>	
	Nickel-Cadium Battery (NiCd) or Nickel-Metal-Hydride Battery (NiMH)
<b>Battery Voltage:</b>	6 to 9 Volts
<b>Nominal:</b>	7.5 Volts
<b>Range:</b>	
<b>Transmit Current Drain (Typical):</b>	1700mA
<b>Receive Current Drain (Rated Audio):</b>	280mA
<b>Standby Current Drain:</b>	90mA
<b>Recommended Battery:</b>	
<b>Ultra-High-Capacity NiMH :</b>	H335AC
or <b>Ultra-High-Capacity NiCd FM:</b>	H223AX*
or <b>NiMH FM IS:</b>	

**Table 2-7** General Specifications (Continued)

General Specifications	
<b>Optional FM (Factory Mutual) Battery:</b>	
<ul style="list-style-type: none"> <li>FM Intrinsically Safe: Class I, II, III, Division 1, Groups D, F, and G</li> </ul>	
<b>Dimensions (HxWxD):</b>	
	NOTE
	2.44" = width at PTT; 2.34" = width at bottom; 1.83" = depth at speaker; 0.97" = depth at keypad
<b>Less Battery:</b>	
6.58" x 2.44" x 1.83"/6.58" x 2.34" x 0.97" (167.13mm x 61.90mm x 46.42mm/167.13mm x 59.49mm x 24.56)	
<b>With Ultra-High Capacity NiMH Battery:</b>	
6.58" x 2.44" x 1.83"/6.58" x 2.34" x 1.65" (167.13mm x 61.90mm x 46.42mm/167.13mm x 59.49 mm x 41.97 mm)	
<b>With Ultra-High Capacity NiCd Battery:</b>	
6.58" x 2.44" x 1.83"/6.58" x 2.34" x 1.65" (167.13mm x 61.90mm x 46.42mm/167.13mm x 59.49 mm x 41.97mm)	
<b>With Ultra-High Capacity NiCd Battery:</b>	
6.58" x 2.44" x 1.83"/6.58" x 2.34" x 1.65" (167.13mm x 61.90mm x 46.42mm/167.13mm x 59.49 mm x 41.97mm)	
<b>With Ultra-High Capacity NiCd Battery:</b>	
6.58" x 2.44" x 1.83"/6.58" x 2.34" x 1.65" (167.13mm x 61.90mm x 46.42mm/167.13mm x 59.49 mm x 41.97mm)	
<b>Weight: (w/Antenna):</b>	
<b>Less Battery:</b>	14.10 oz (383 gm)
<b>With Ultra-High Cap. NiMH:</b>	23.45 oz (644 gm)
<b>With Ultra-High Cap. NiCd:</b>	25.19 oz (693 gm)
<b>With NiMH FM IS::</b>	23.45 oz (644 gm)
* Specifications subject to change without notice.	

**Table 2-8** Receiver Specifications

Receiver	
<b>Frequency Range:</b>	851–870 MHz
<b>Bandwidth:</b>	19 MHz
<b>Usable Sensitivity (typical) (12dB SINAD):</b>	0.35 V
<b>Intermodulation (typical):</b>	—74 dB



**Table 2-8** Receiver Specifications (Continued)

<b>Receiver</b>	
<b>Selectivity</b>	
<b>(25kHz Adjacent Channel):</b>	—70dB
<b>Spurious Rejection:</b>	—70dB
<b>Frequency Stability</b>	
<b>(-30 to +60°C; 25°C reference):</b>	$\pm .00015\%$
<b>Rated Audio:</b>	500mW
<b>Distortion (At Rated Audio):</b>	3% Typical
<b>Channel Spacing:</b>	25 kHz
* Specifications subject to change without notice.	

**Table 2-9** Transmitter Specifications

<b>Transmitter</b>	
<b>RF Power:</b>	3 Watts
<b>Frequency Range:</b>	806–825 MHz
<b>Frequency Stability</b>	$\pm .00015\%$
<b>(-30 to +60°C; 25°C ref.):</b>	
<b>Emission (Conducted and Radiated):</b>	—46dBw
<b>FM Hum and Noise (Companion Receiver):</b>	—40dB
<b>Distortion:</b>	3% Typical
<b>Modulation Limiting:</b>	$\pm 5$ kHz
<b>(821–824MHz):</b>	$\pm 4$ kHz
<b>Emissions Designators:</b>	
20K0F1E, 16K0F3E, 15K0F2D, 15K0F1D and 8K10F1E	
* Specifications subject to change without notice.	

**This page intentionally left blank.**

# Overview

---

This manual covers information needed for level one troubleshooting. Level one troubleshooting consists of radio programming, radio alignment, knobs replacement, and installation and removal of antenna, belt clip, battery, and universal connector cover. This will be the only level of service allowed for the service centers, self-maintained customers, and distributors for the first six months of the life of this product.

Included in this manual are radio specifications for the 800MHz frequency band, a general description of XTS 3000 models, recommended test equipment, service aids, radio alignment procedures, general maintenance recommendations, and procedures for basic assembly and disassembly.

## 3.1 Notations Used in This Manual

---

Throughout the text in this publication, you will notice the use of warnings, cautions, and notes. These notations are used to emphasize that safety hazards exist, and care must be taken and observed.



### NOTE

An operational procedure, practice, or condition that is essential to emphasize.



### CAUTION

**CAUTION** indicates a potentially hazardous situation which, if not avoided, might result in equipment damage.



### WARNING

**WARNING** indicates a potentially hazardous situation which, if not avoided, could result in death or injury.

**DANGER**

**DANGER** indicates an imminently hazardous situation which, if not avoided, will result in death or injury.

## 3.2 Radio Description

The ASTRO Digital XTS 3000 radios are among the most sophisticated two-way radios available. The radio is presently available in the 800MHz band; radios in the UHF and VHF bands will be available by the end of 1996.

One of the newest in a long line of quality Motorola products, the ASTRO Digital XTS 3000 radio provides improved voice quality across more coverage area. The digital process called “embedded signalling” intermixes system signalling information with digital voice, resulting in improved system reliability and the capability of supporting a multitude of advanced features. Such features add up to better, more cost-effective two-way radio communications.

ASTRO Digital XTS 3000 radios are available in two basic models. [Table 3-1](#) provides a description of their basic features.

**Table 3-1** ASTRO XTS 3000 Basic Features

Feature	Model I	Model II	Model III
Display	None	LCD 4 lines/12 characters per line	LCD 4 lines/ 12 characters per line
Keypad	None	3x2 button	3x6 button
Channel Capability	48	255	255
Dialing from Prestored List	No	Yes	Yes
Programmable Softkeys	No	Yes	Yes

## 3.3 FLASHPort

---

The ASTRO Digital XTS 3000 radio utilizes Motorola's revolutionary FLASHPort technology. FLASHPort makes it possible to add software that drives the radio's capabilities both at the time of purchase and later on. Previously, changing a radio's features and capabilities meant significant modifications, or buying a new radio. But now, similar to how a computer can be loaded with different software, the radio's features and capabilities can be upgraded with FLASHPort software.

**This page intentionally left blank.**

# Basic Maintenance

---

This section of the manual describes preventive maintenance and handling precautions. Each of these topics provides information vital to the successful operation and maintenance of your radio.

## 4.1 Preventive Maintenance

---

The ASTRO Digital XTS 3000 radios do not require a scheduled preventive maintenance program; however, periodic visual inspection and cleaning is recommended.

### 4.1.1 Inspection

Check that the external surfaces of the radio are clean, and that all external controls and switches are functional. A detailed inspection of the interior electronic circuitry is not needed.

### 4.1.2 Cleaning

The following procedures describe the recommended cleaning agents and the methods to be used when cleaning the external surfaces of the radio. External surfaces include the housing assembly and battery case. These surfaces should be cleaned whenever a periodic visual inspection reveals the presence of smudges, grease, and/or grime.

The only recommended agent for cleaning the external radio surfaces is a 0.5% solution of a mild dish washing detergent, such as JOY<sup>®</sup>, in water.



#### CAUTION

**The effects of certain chemicals and their vapors can have harmful results on certain plastics. Aerosol sprays, tuner cleaners, and other chemicals should be avoided.**

### 4.1.2.1 Cleaning External Plastic Surfaces

The detergent-water solution should be applied sparingly with a stiff, nonmetallic, short-bristled brush to work all loose dirt away from the radio. A soft, absorbent, lint-free cloth or tissue should be used to remove the solution and dry the radio. Make sure that no water remains entrapped near the connectors, cracks, or crevices.

## 4.2 Handling Precautions

This section outlines handling precautions when working with the XTS 3000 R Radio.

### 4.2.1 XTS 3000 R Radios Only



#### NOTE

In XTS 3000 R radios, the “R” signifies the radio is a Rugged-type radio designed to withstand adverse field conditions such as being submersed in water.



#### CAUTION

- The XTS 3000 R radio casting has a vent hole that allows for pressure equalization in the radio. Never poke this vent with any objects such as needles, tweezers or screwdrivers. This creates a leak path into the radio and the radio’s submersibility is lost.
- The pressure equalization vent is located on the chassis, just below the battery contact. Never obstruct or cover the two slots with any object, including a label. Ensure that no oily substances come in contact with this vent.



- The XTS 3000 R radio is designed to be submersed to a maximum depth of 6 feet and a maximum submersion time of 4 hours. Exceeding either maximum limit may result in damage to the radio.
  - a.** If the radio has been submersed in water, shake the radio well to remove any water that may be trapped inside the speaker grille and microphone port. Otherwise, the water could cause decreased audio capabilities.
  - b.** If the radio's battery contact area has been exposed to water, dry and clean battery contacts on both the radio and the battery before attaching the battery to the radio. Otherwise, the water could short-circuit the radio.
  - c.** If the radio has been submersed in a corrosive medium (such as salt water), rinse the radio and battery in fresh water and dry the radio and battery.
  - d.** To clean the exterior surfaces of the radio, use a diluted solution of mild dish washing detergent and fresh water (one teaspoon of detergent to one gallon of water).
  - e.** Do not disassemble the radio. This could damage radio seals and result in leak paths into the radio. Radio maintenance should be performed only by a qualified service person.
  - f.** Elastomer technology materials used for seals in rugged portable radios can age with time and environmental exposure. Therefore, Motorola recommends that rugged radios be checked annually to assure the watertight integrity of the radio.

Complementary metal-oxide semiconductor (CMOS) devices, and other high technology devices, are used in this family of radios. While the attributes of these devices are many, their characteristics make them susceptible to damage by electrostatic discharge (ESD) or high-voltage charges. Damage can be latent, resulting in failures occurring weeks or months later. Therefore, special precautions must be taken to prevent device damage during disassembly, troubleshooting, and repair. Handling precautions are mandatory for this radio, and are especially important in low-humidity conditions. At this time, troubleshooting and repair of the radio will not be supported by the field or self-maintained customer. DO NOT attempt to disassemble the radio.

**This page intentionally left blank.**

# Recommended Test Equipment and Service Aids

This chapter discusses recommended test equipment and service aids.

## 5.1 Recommended Test Equipment

The list of equipment contained in [Table 5-1](#) includes all of the standard test equipment required for servicing two-way portable radios, as well as several unique items designed specifically for servicing this family of radios. The “Characteristics” column is included so that equivalent equipment may be substituted; however, when no information is provided in this column, the specific Motorola model listed is either a unique item or no substitution is recommended.

**Table 5-1** Recommended Test Equipment

Motorola Model Number	Description	Characteristics	Application
R2670 or R2600	System Analyzer	This monitor will substitute for items with an asterisk (*).	Frequency/deviation meter and signal generator for wide-range troubleshooting and alignment.
R1049A*	Digital Multimeter		Recommended for AC/DC voltage and current measurements.
R1150C*	Code Synthesizer		Injection of audio and digital signalling codes.
S1053D* SKN6008A* SKN6001A*	AC Voltmeter Power Cable for Meter Test Leads for Meter	1mV to 300V, 10–Megohm input impedance	Audio voltage measurements.

**Table 5-1** Recommended Test Equipment (Continued)

Motorola Model Number	Description	Characteristics	Application
R1094A	Dual-Trace Oscilloscope	20MHz bandwidth 5mV to 5V/division	Waveform measurements
S1350C* ST1213B(VHF)* ST1223B(UHF)*	Wattmeter Plug-In Element RF Dummy Load	50-ohm, $\pm 5\%$ accuracy 10 watts, maximum 0-1000MHz, 300W	Transmitter power output measurements.
R1065	Load Resistor	10-watt Broadband	For use with wattmeter.
S1339A	RF Millivolt Meter	100 $\mu$ V to 3V RF	RF-level measurements.
R1013A*	SINAD Meter		Receiver sensitivity measurements.
S1347D or S1348D (programmable)	DC Power Supply	1-20Vdc, 0-5 Amps current limited	Bench supply for 7.5Vdc

## 5.2 Service Aids

Refer to [Table 5-2](#), Service Aids, for a listing and description of the service aids designed specifically for servicing this family of radios. These kits and/or parts are available from the Motorola Parts Division offices listed in the “Replacement Parts Ordering” section located on the inside back cover of this manual. While all of these items are available from Motorola, most are standard shop equipment items, and any equivalent item capable of the same performance may be substituted for the item listed.

**Table 5-2** Service Aids

Motorola Part Number	Description	Application
RKN-4035D	RIB/Radio/Test Set Cable	Connects radio to RTX-4005B Test Box and RIB.
REX-4424	Battery Eliminator	Interconnects radio to power supply.
RLN-4460A, or RTX-4005B, or both RTX-4005A and RPX-4665A	Portable Test Set	Enables connection to the universal connector. Allows switching for radio testing.
Field Modification Kit RLN-1015A or RLN-4008B	Radio Interface Box	Enables communications between the radio and the computer's serial communications adapter.

**Table 5-2** Service Aids (Continued)

Motorola Part Number	Description	Application
01-80357A57	Wall-Mounted Power Supply	Used to supply power to the RIB (120 Vac).
01-80358A56	Wall-Mounted Power Supply	Used to supply power to the RIB (220 Vac).
30-80369B71 or 30-80369B72	Computer Interface Cable	Use B72 for the IBM PC AT. All other IBM models use B71. Connects the computer's serial communications adaptor to the RIB.
RVN -4100F	Radio Service Software	Software on 3-1/2 in. and 5-1/4 in. floppy disks.
58-80348B33	SMA to BNC Adaptor	Adapts radio's antenna port to BNC cabling of test equipment.

## 5.3 Field Programming Equipment

This family of radios can be aligned and programmed in the field. This requires specific equipment and special instructions. Refer to the applicable *Radio Service Software User's Guide* for complete field programming information.

**This page intentionally left blank.**

## Performance Checks

This section covers performance checks used to verify the radio meets published specifications. The recommended test equipment listed in the previous section approaches the accuracy of the manufacturing equipment, with a few exceptions. Accuracy of the equipment must be maintained in compliance with the manufacturer's recommended calibration schedule.

### 6.1 Setup

Supply voltage can be connected from the battery eliminator. The equipment required for alignment procedures is connected as shown in the "Radio Alignment Test Setup" diagram (Table 5-1).

Initial equipment control settings should be as indicated in the following table, and should hold for all alignment procedures except as noted in Figure 7-1.

**Table 6-1** Initial Equipment Control Settings

System Analyzer	Test Set	Power Supply
<b>Monitor Mode:</b> Pwr Mon	<b>Spkr Set:</b> A	<b>Voltage:</b> 7.5Vdc
<b>RF Attn:</b> —70dB	<b>Spkr/Load:</b> Speaker	<b>DC On/Standby:</b> Standby
<b>AM, CW, FM:</b> FM	<b>PTT:</b> OFF (center)	<b>Volt Range:</b> 10Vdc
<b>O'scope Source:</b> Mod <b>O'scope Horiz:</b> 10mSec/Div <b>O'scope Vert:</b> 2.5kHz/Div <b>O'scope Trig:</b> Auto <b>O'scope Image:</b> Hi <b>O'scope BW:</b> Nar <b>O'scope Squelch:</b> Mid CW <b>O'scope Vol:</b> 1/4 CW		<b>Current:</b> 2.5 Amps

## 6.2 Test Mode

This section describes test mode functionality.

### 6.2.1 Entering Test Mode

Follow the procedure below to enter test mode.

**Procedure 6-1** Entering Test Mode

<b>1</b>	Turn the radio on.
<b>2</b>	Within 10 seconds after the self test is complete, press <b>Side Button 3</b> five times in succession.
<b>3</b>	The radio will show a series of displays that will give information regarding various version numbers and subscriber specific information. The displays are described by the following table, “Front Panel Access Test Mode Displays” (Table 6-2).
<b>4</b>	Press <b>Side Button 1</b> to stop the displays and put the radio into the Control Top and Keypad test mode. The test mode menu CH TEST is displayed. Go to the “Control Top and Keypad Test Mode” section.
	 <div style="display: inline-block; background-color: #00a0e3; color: white; padding: 2px 5px; font-weight: bold; margin-left: 10px;">NOTE</div> <p style="margin-left: 20px;">Each press of the <b>Side Button 1</b> will toggle between CH TEST and RF TEST.</p>
<b>5</b>	<b>OR</b>
<b>6</b>	Press the <b>Top Programmable Button (Emergency button)</b> to stop the displays and put the radio into the RF test mode. The test mode menu 1 CSQ will be displayed, indicating test frequency 1, Carrier SQelch mode. Go to the RF Test Mode section.

The table below describes front panel access test mode displays.

**Table 6-2** Front Panel Access Test Mode Displays

Name of Display	Description	Appears
“SERVICE”	The literal string indicates the radio has entered test mode.	Always
Radio Host Software Version	The version of radio firmware is displayed.	Always
DSP Software Version	The version of firmware being used by the DSP.	Always
EMC Secure Version	Version of the encryption hardware.	When the radio is secure equipped.



**Table 6-2** Front Panel Access Test Mode Displays (Continued)

Name of Display	Description	Appears
Encryption Type 1	Type of encryption being used.	When the radio is secure equipped.
Encryption Type 2	Type of encryption being used.	When the radio is secure equipped.
Model Number	The radio's model number as programmed in the codeplug.	Always
Serial Number	The radio's serial number as programmed in the codeplug.	Always
ROM Size	The memory capacity of the FLASH part.	Always
FLASHcode	The FLASHcodes as programmed as a part of the radio's codeplug.	Always

**NOTE**

All displays are temporary and will expire without any user intervention. If information is longer than the physical length of the radio's display, the information wraps to the next display. After the last display, RF TEST is displayed.

## 6.2.2 RF Test Mode

When the ASTRO Digital XTS 3000 radio is operating in its normal environment, the radio's microcomputer controls the RF channel selection, transmitter key-up, and receiver muting. However, when the unit is on the bench for testing, alignment, or repair, it is removed from its normal environment. It cannot receive commands from its system and the internal microcomputer will not key the transmitter nor unmute the receiver. This prevents the use of normal tune-up procedures. To solve this problem, a special routine, called TEST MODE or "air test," has been incorporated into the radio.

### Procedure 6-2 RF Test Mode Procedure

<b>1</b>	Each additional press of <b>Side Button 3</b> will advance to the next test channel. (Refer to <a href="#">Table 6-3</a> .)
<b>2</b>	Pressing <b>Side Button 2</b> will scroll through and access test environments as shown in <a href="#">Table 6-4</a> .

**NOTE**

Transmit into a load when keying a radio under test.

**Table 6-3** Test Frequencies

Test Channel	VHF	UHF Band 1	UHF Band 2	800MHz
TX#1	136.025	403.100	450.025	806.0125
RX#1	136.075	403.150	450.075	851.0625
TX#2	142.125	424.850	465.225	815.0125
RX#2	142.075	424.900	465.275	860.0625
TX#3	154.225	438.050	475.225	824.9875
RX#3	154.275	438.100	475.275	869.9375
TX#4	160.125	444.050	484.975	851.0125
RX#4	160.175	444.100	485.025	851.0625
TX#5	168.075	456.350	500.275	860.0125
RX#5	168.125	456.400	500.225	860.0625
TX#6	173.975	463.700	511.975	869.9875
RX#6	173.925	463.750	511.925	869.9375
TX#7	177.975	469.650	519.975	None
RX#7	177.925	469.700	519.925	None

Test environments are described in the table below.

**Table 6-4** Test Environments

Display	Description	Function
CSQ	Carrier Squelch	<b>RX:</b> Unsquelch if carrier detected <b>TX:</b> mic audio
TPL	Tone Private-Line	<b>RX:</b> Unsquelch if carrier and tone (192.8 Hz) detected <b>TX:</b> mic audio + tone (192.8 Hz)
		<b>RX:</b> none <b>TX:</b> 1200 Hz tone <sup>1</sup>

1. All deviation values are based on deviation tuning of this mode.

## 6.2.3 Control Top and Keypad Test Mode

See procedure below to enter control top and keypad test mode.

### Procedure 6-3 Entering Control Top and Keypad Test Mode

<b>1</b>	Next, press and hold the <b>Top Programmable Button</b> ; all segments on the display will light, and the LED on the control top will illuminate a red color.
<b>2</b>	Release the <b>Top Programmable Button</b> ; 3/0 appears, which indicates that the <b>Top Programmable Button</b> is in the open condition.
<b>3</b>	Press the <b>Top Programmable Button</b> again; 3/1 appears, which indicates that the <b>Top Programmable Button</b> is in the closed condition.
<b>4</b>	Rotate the <b>Mode/Zone Selector Switch</b> ; 4/0 through 4/15 appears, which indicates that the selector switch is in mode/zone position 1 through 15.
<b>5</b>	Rotate the <b>Two-Position Concentric Switch</b> ; 65/0 and 65/1 appear.
<b>6</b>	Rotate the <b>Three-Position Programmable Switch</b> ; 67/0, 67/1, and 67/2 appear.
<b>7</b>	Rotate the <b>Volume Control</b> ; 2/0 through 2/255 appear.
<b>8</b>	Press <b>Side Button 1</b> ; 96/1 appears; release, 96/0 appears.
<b>9</b>	Press <b>Side Button 2</b> ; 97/1 appears; release, 97/0 appears.
<b>10</b>	Press <b>Side Button 3</b> ; 98/1 appears; release, 98/0 appears.
<b>11</b>	Press the <b>PTT Switch</b> ; 1/1 appears; release, 1/0 appears.
<b>12</b>	Keypad Checks: - Press <b>0</b> , 48/1 appears; release, 48/0 appears. - Press <b>1</b> , 49/1 appears; release, 49/0 appears. - Press <b>2</b> (ABC), 50/1 appears; release, 50/0 appears. - Press <b>3</b> (DEF), 51/1 appears; release, 51/0 appears. - Press <b>4</b> (GHI), 52/1 appears; release, 52/0 appears. - Press <b>5</b> (JKL), 53/1 appears; release, 53/0 appears. - Press <b>6</b> (MNO), 54/1 appears; release, 54/0 appears. - Press <b>7</b> (PRS), 55/1 appears; release, 55/0 appears. - Press <b>8</b> (TUV), 56/1 appears; release, 56/0 appears. - Press <b>9</b> (WXYZ), 57/1 appears; release, " 57/0" appears. - Press <b>*</b> , 58/1 appears; release, 58/0 appears. - Press <b>#</b> , 59/1 appears; release, 59/0 appears. - Press <b>◀</b> , 128/1 appears; release, 128/0 appears. - Press <b>HOME</b> , 129/1 appears; release, 129/0 appears. - Press <b>▶</b> , 130/1 appears; release, 130/0 appears. - Press the left-hand <b>⊖</b> key on the top row of keys, 131/1 appears; release, 131/0 appears. - Press the center <b>⊖</b> key, 132/1 appears; release, 132/0 appears. - Press the right-hand <b>⊖</b> key, 133/1 appears; release, 133/0 appears.

The following table contains information for receiver performance checks.

**Table 6-5** Receiver Performance Checks

Test Name	System Analyzer	Radio	Test Set	Comments
Reference Frequency	<b>Mode:</b> PWR MON 4th channel test frequency <sup>1</sup> <b>Monitor:</b> Frequency error. Input at RF In/Out	TEST MODE, 4 CSQ output at antenna	PTT to continuous (during the performance checks)	Frequency error to be $\leq \pm 1.2\text{kHz}$
Rated Audio	<b>Mode:</b> GEN <sup>2</sup> <b>Output Level:</b> 1.0mV RF 4th channel test frequency <b>MOD:</b> 1kHz tone at 3kHz deviation <b>Monitor:</b> Frequency error. Input at RF In/Out	TEST MODE, 4 CSQ	PTT to OFF (center); meter selector to Audio PA	Set volume control to 3.74Vrms
Distortion	As above, except to distortion	As above	As above	Distortion <3.0%
Sensitivity (SINAD)	As above, except SINAD; lower the RF level for 12dB SINAD	As above	PTT to OFF (center)	RF input to be 0.35 $\mu\text{V}$
Noise Squelch Threshold (only radios with conventional system need to be tested)	RF level set to 1mV RF	As above	PTT to OFF (center); meter selection to Audio PA; spkr/load to speaker	Set volume control to 3.74Vrms
	As above, except change frequency to a conventional system. Raise RF level from zero until radio unsquelches.	Out of TEST MODE; select a conventional system	As above	Unsquelch to occur at <0.25 $\mu\text{V}$ . Preferred SINAD = 8–10dB

1. See Table 6.
2. See Table 6.

The following table contains information necessary for transmitter performance checks.

**Table 6-6** Transmitter Performance Checks

Test Name	System Analyzer	Radio	Test Set	Comments
Reference Frequency	<b>Mode:</b> PWR MON 4th channel test frequency <sup>1</sup> <b>Monitor:</b> Frequency error. Input at RF In/Out	TEST MODE, 4 CSQ	PTT to continuous (during the performance checks)	Frequency error to be $\leq \pm 1.2\text{kHz}$
Power RF	As above	As above, 4 CSQ	As above	Refer to Maintenance Specifications page in front of manual.
Voice Modulation	<b>Mode:</b> PWR MON 4th channel test frequency <sup>2</sup> attenuation to $-70$ , input to RF In/Out. <b>Monitor:</b> DVM, ac Volts. Set 1kHz Mod Out level for 0.025 Vrms at test set, 80m Vrms at ac/dc test set jack	As above, 4 CSQ	As above, meter selector to mic	<b>Deviation:</b> <b>800MHz:</b> $\geq 3.6\text{Hz}$ but $\leq 5.0\text{kHz}$
Voice Modulation (Internal)	<b>Mode:</b> PWR MON 4th channel test frequency <sup>3</sup> attenuation to $-70$ , input to RF In/Out.	TEST MODE, 4 CSQ, output at antenna	Remove modulation input	Press PTT switch on radio. Say “four” loudly into the radio mic. <b>Measure deviation:</b> <b>800MHz:</b> $\geq 3.8\text{kHz}$ but $\leq 5.0\text{kHz}$
PL Modulation (radios with conventional, clear mode, coded squelch operation only)	Change frequency to a conventional transmit frequency; BW to narrow	Conventional coded squelch personality (clear mode operation) 4 TPL	As above	<b>Deviation:</b> <b>800MHz:</b> $\geq 500\text{Hz}$ but $\leq 1000\text{kHz}$

**Table 6-6** Transmitter Performance Checks (Continued)

Test Name	System Analyzer	Radio	Test Set	Comments
Talkaround Modulation (radios with conventional, clear mode, talkaround operation only)	Change frequency to conventional talkaround frequency. <b>Mode:</b> PWR MON deviation, attenuation to —70, input to RF In/Out. <b>Monitor:</b> DVM, ac volts Set 1kHz Mod Out level for 25mVrms at test set.	Conventional talkaround personality (clear mode operation) 1 CSQ	As above	<b>Deviation:</b> <b>800MHz:</b> $\geq 3.8\text{Hz}$ but $\leq 5.0\text{kHz}$
Talkaround Modulation (radios with conventional, secure mode, talkaround operation only <sup>4</sup> )	Change frequency to conventional talkaround frequency. <b>Mode:</b> PWR MON deviation, attenuation to —70, input to RF In/Out. <b>Monitor:</b> DVM, AC volts <b>Mod:</b> 1kHz out level for 25mVrms at test set.	Conventional talkaround personality (secure mode operation). Load key into radio 1 sec.	As above	<b>Deviation:</b> <b>800MHz:</b> $\geq 3.6\text{Hz}$ but $\leq 4.4\text{kHz}$

1. See Table 6.

2. See Table 6.

3. See Table 6.

4. The secure mode, talkaround modulation test is only required for trac mode radios which do not have clear mode talkaround capability.

# ALIGNMENT PROCEDURE

---

The following procedures are to be used for the alignment of all Motorola ASTRO Digital portable radios with HP8901B Modulation Analyzer and R2670 Communication Analyzer.

These procedures are to be used in conjunction with the instructions listed in the Motorola Radio Service Software (RSS) / Customer Programming Software (CPS) tuner under the Help key for each test to be performed. However, in the event of a conflict in procedure, those specified in this document shall take precedence.



## CAUTION

**Do NOT switch radios in the middle of any SERVICE procedure. Always use the EXIT key to return to the MAIN menu screen before disconnecting the radio. Improper exits from the SERVICE screens may leave the radio in an improperly configured state and result in seriously degraded radio or system performance.**

## 7.1 General

---

An IBM personal computer (PC) and radio service software (RSS) are required to align the radio. Refer to the applicable RSS manual for installation and setup procedures for the software. To perform the alignment procedures, the radio must be connected to the PC, radio interface box (RIB), and a universal test set as shown in [Figure 7-1](#).

**Figure 7-1** Radio Alignment Test Setup

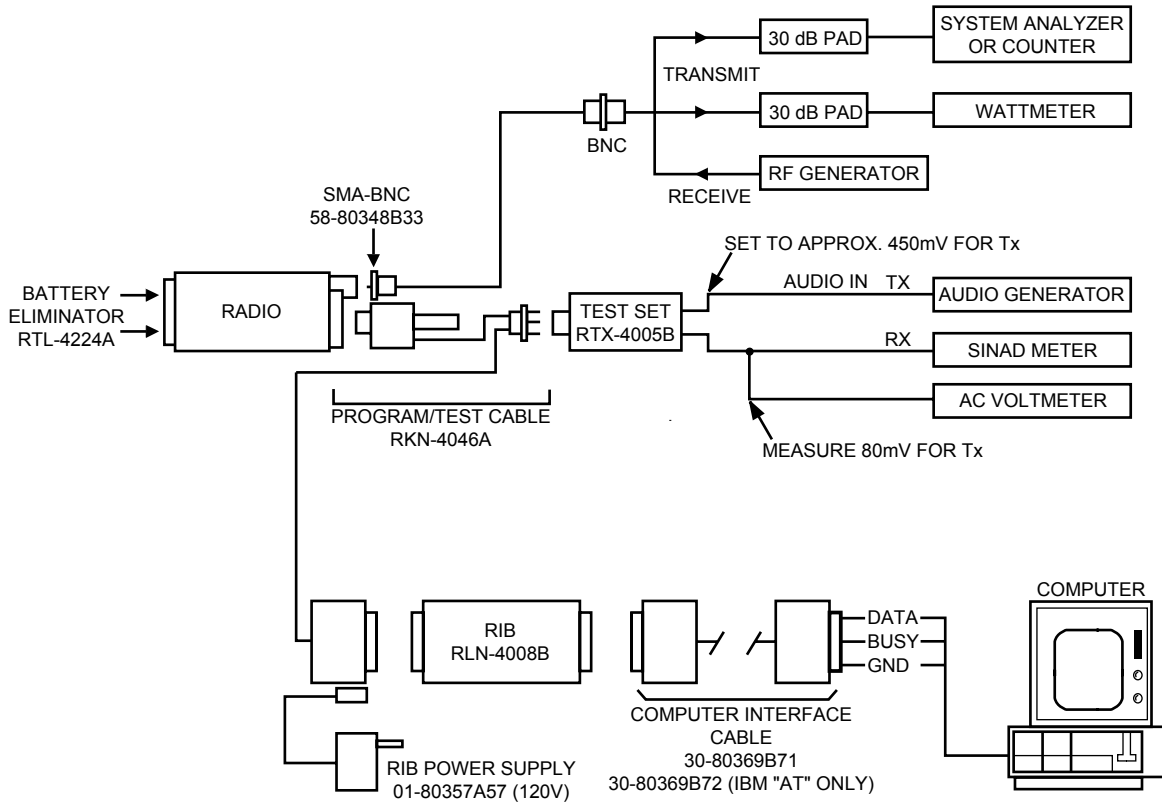

All service and tuning procedures are performed from the **Service** menu, which is selected by pressing **F2** from the **Main Menu**. [Figure 7-2](#) illustrates how the RSS alignment **Service** screens are organized.

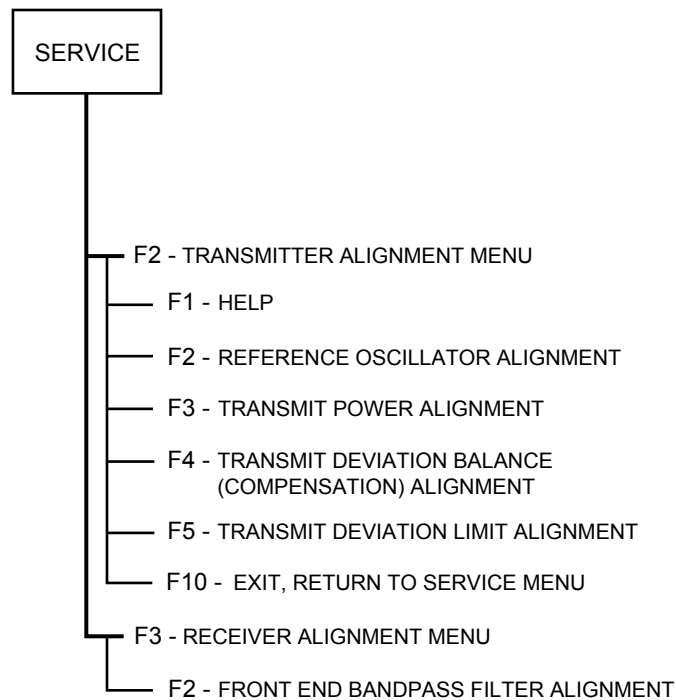
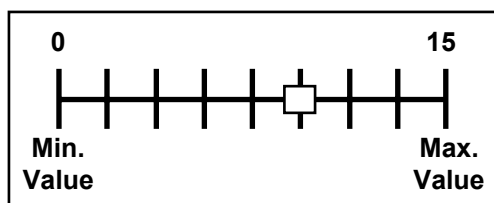

**Figure 7-2** RSS Service Menu Layout

All **Service** screens read and program the radio codeplug directly; you do NOT have to use the **RSS Get/Save** functions to use the **Service** menus.

The **Service** screens introduce the concept of the softpot, an analog SOFTware-controlled POTentiometer used for adjusting all transceiver alignment controls.

Each **Service** screen provides the capability to increase or decrease the ‘softpot’ value with the keyboard **Up/Down** arrow keys. A graphical scale is displayed indicating the minimum, maximum, and proposed value of the softpot, as shown in [Figure 7-3](#).

**Figure 7-3** Softpot Concept

Adjusting the softpot value sends information to the radio to increase (or decrease) a DC voltage in the corresponding circuit. For example, pressing the Up arrow key at the **Reference Oscillator** screen instructs the radio’s microcomputer to increase the voltage across a varactor in the reference oscillator, which increases the frequency.

In ALL cases, the softpot value is just a relative number corresponding to a digital-to-analog (D/A) generated voltage in the radio.

Perform the following procedures in the sequence indicated.

**NOTE**

Some of the following screens may vary depending upon the radio under test and the version of radio service software you are using. Refer to your Radio Service Software user guide.

## 7.2 Reference Oscillator

---

The following section describes service of the reference oscillator.

### 7.2.1 Preventative Maintenance

Radios are shipped from the factory with worst-case frequency error of +/- 250 Hz for VHF, +/-750 Hz for UHF, +/-750Hz for 800 MHz and +/- 1KHz for 900 MHz. These specifications are tighter than the most stringent FCC required specs of 2 ppm, 2 ppm, 1.5 ppm and 1.5 ppm (part per million) for VHF, UHF, 800 MHz, and 900 MHz respectively, within which the radio will operate to specification.

For radios that have been in storage for over 6 months from the factory ship date, the reference oscillator should be checked upon initial radio deployment to the field. It is also strongly suggested that the reference oscillator be checked every time the radio is serviced or once a year, whichever comes first.

The crystal contained in the reference oscillator naturally drifts over time due to its aging characteristic. This drift can be expected to be in the negative direction from the original factory setting. Therefore, periodic (annual) adjustment of the reference oscillator is important for proper radio operation. Improper adjustment can result not only in poor performance, but also in interference with other users operating on adjacent channels. A recommended test setup and tuning procedure is detailed in the alignment section of this manual. The frequency counter used for this procedure must have a stability of 0.1 ppm or better.

### 7.2.2 Reference Oscillator Alignment

Adjustment of the reference oscillator is critical for proper radio operation. Improper adjustment will result not only in poor operation, but also in a misaligned radio that will interfere with other users operating on adjacent channels. For this reason, the reference oscillator should be checked every time the radio is serviced. The frequency counter used for this procedure must have a stability of 0.1 ppm (or better).

This test can be done with either the R2670 Communication Analyzer or the 8901B Modulation Analyzer.

### 7.2.2.1 Initial Setup Using R-2670 and 8900 Series Analyzers

Use the following procedure for initial setup using an R-2670 Communication Analyzer.

#### Procedure 7-1 Initial Setup Using the R-2670 Communication Analyzer

1	Set <b>RF Control:</b> to <b>MONITOR</b> .
2	Set <b>B/W:</b> to <b>WB</b> .
3	Set <b>Freq:</b> to <b>RSS frequency under test</b> .
4	Set <b>Attenuation:</b> to <b>20dB</b>
5	Set <b>Mon RF in:</b> to <b>RF I/O</b> .
6	Set <b>Meter:</b> to <b>RF Display</b> .
7	Set <b>Mode:</b> to <b>STD</b> .
8	Set <b>Input Level:</b> to <b>uV</b> or <b>W</b> .
9	Set <b>Display:</b> to <b>Bar Graphs</b> .
10	Set <b>Squelch:</b> to <b>Midrange</b> or adjust as necessary.

Use the following procedure for initial setup using an 8900 Series Modulation Analyzer.

#### Procedure 7-2 Initial Setup Using the 8900 Series Modulation Analyzer

1	Press the green <b>Automatic Operation</b> button on the analyzer.
2	Press the <b>Freq</b> key.
3	Type <b>7.1</b> followed by <b>SPCL</b> button to set the 8901B modulation analyzer for maximum accuracy.
4	Continue with RSS or CPS procedure below.

#### 7.2.2.1.1 RSS and CPS Procedures

Use the following RSS procedure when applicable.

#### Procedure 7-3 RSS Procedure

1	Read the radio using RSS (Radio Service Software).
2	From the <b>Service Menu</b> , press <b>F2</b> to select <b>Transmitter Alignment Menu</b> .
3	Press <b>F2</b> again to select <b>Reference Oscillator</b> alignment screen.
4	If using the R-2670, in the <b>RF Control</b> section of the R-2670 enter the frequency displayed on the RSS screen. Under the <b>Meter</b> section of the display, choose <b>RF Display</b> .
5	Press <b>F6</b> to key the radio. The RSS screen will indicate that the radio is transmitting.
6	Wait 5 seconds until the analyzer reading settles. Record the transmitter frequency (or note the frequency error reading on the screen).

**Procedure 7-3** RSS Procedure (Continued)

<b>7</b>	Use the <b>Up/Down</b> arrow key on your PC key board to adjust the reference oscillator softpot value. Allow about 5 seconds for the analyzer's frequency reading to settle after each change. Adjust the frequency error in accordance with <a href="#">Table 7-1</a> .
<b>8</b>	Press <b>F6</b> again to dekey the radio.
<b>9</b>	Press <b>F8</b> to program the new softpot value.
<b>10</b>	Press <b>F10</b> once to return to <b>Transmitter Alignment</b> menu.

The following table contains target band information for Reference Oscillator Alignment.

**Table 7-1** Reference Oscillator Alignment

<b>Band</b>	<b>Target</b>
VHF	+/-60 Hz
UHF	+/-150 Hz
800 MHz	0Hz/+300Hz

Use the following CPS procedure when applicable.

**Procedure 7-4** CPS Procedure

<b>1</b>	Read the radio (File/Read Device).
<b>2</b>	Double click on <b>ASTRO Tuner</b> to select it.
<b>3</b>	Double click on <b>Transmitter Alignments</b> to select it.
<b>4</b>	Double click on <b>Reference Oscillator</b> to select it.
<b>5</b>	If using the R2670, in the <b>RF control</b> section of the R-2670 enter the frequency displayed on the RSS screen. Under the <b>Meter</b> section of the display, choose <b>RF Display</b> .
<b>6</b>	Select the <b>PTT button</b> on the screen to key the radio. The screen indicates whether the radio is transmitting.
<b>7</b>	Wait 5 seconds until the analyzer reading settles. Record the transmitter frequency.
<b>8</b>	Click on the <b>Up/Down</b> arrow on the monitor to adjust the reference oscillator softpot value. Allow about 5 seconds for the analyzer's frequency reading to settle after each change. Adjust the frequency error in accordance with <a href="#">Table 7-1</a> .
<b>9</b>	Select the <b>Program</b> button on the screen to de-key the radio and save the tuned values.
<b>10</b>	Select the <b>Close</b> button on the screen to return to the <b>Transmitter Alignments</b> menu.

## 7.3 Transmit Power Alignment

This test can be done using the R2670 Communication Analyzer, the 8900 series Modulation Analyzer or a Power Meter. Setup the equipment to read Output Power.



### NOTE

- This alignment procedure adjusts the transmit power of the radio and must be performed for three different power levels (Low, Mid, and High), at multiple frequencies for each power level, to allow for proper alignment across the entire RF band.
- All power measurements are to be made at the antenna port.
- The transmitter power setting keeps the radiated power at or below the level specified in the exclusionary clause for low power devices of IEEE Standard C95.1-1991.

### 7.3.1 RSS and CPS Procedures

Use the following RSS procedure when applicable.

#### Procedure 7-5 RSS Procedure

<b>1</b>	From the <b>Service</b> menu, press <b>F2</b> to select the <b>Transmitter Alignments</b> menu.
<b>2</b>	Press <b>F3</b> to select the <b>Transmit Power</b> alignment screen. The screen will indicate the transmit frequencies and power levels to be used.
<b>3</b>	Press <b>Tab</b> key (or <b>Enter</b> or <b>Return</b> ) to select a frequency field (starting with the highest frequency shown). Then, press <b>F6</b> to key the radio. The screen will indicate that the radio is transmitting.
<b>4</b>	Use the <b>Up/Down</b> arrow keys to adjust the transmit power per the values specified in the specifications.
<b>5</b>	Press <b>F6</b> to dekey the radio.
<b>6</b>	Press <b>F8</b> to program the softpot value.
<b>7</b>	Repeat steps 3-6 for the remaining frequencies.
<b>8</b>	Press <b>F10</b> once to return to the <b>Transmitter Alignment</b> menu, or press <b>F10</b> twice to return to the <b>Service</b> menu.

Use the following CPS procedure when applicable.

**Procedure 7-6** CPS Procedure

<b>1</b>	Under the <b>Transmitter Alignments</b> menu, select <b>TX Power High</b> . The screen will indicate the transmit frequencies to be used.
<b>2</b>	Select a frequency field (starting with the highest frequency shown) and select the <b>PTT</b> button to key the radio.
<b>3</b>	Select the <b>Up/Down</b> arrow keys under <b>New Softpot Value</b> window to adjust the transmit power per the values specified in the specifications.
<b>4</b>	Select the <b>PTT</b> button again to dekey the radio.
<b>5</b>	Select <b>Program</b> button to program the softpot value.
<b>6</b>	Repeat steps 2-5 for the remaining frequencies.
<b>7</b>	Select the <b>Close</b> button to return to the <b>Transmitter Alignments</b> menu.
<b>8</b>	Repeat steps 1-7 for the remaining Transmit Power Levels.

## 7.4 Transmit Deviation Balance (Compensation) Alignment

This test can be done with either the R-2670 Communication Analyzer or the 8900 series Modulation Analyzer. The instrument of choice is the R2670 analyzer.

Use the following procedure for initial setup using an R-2670 Communication Analyzer.

**Procedure 7-7** Initial Setup Using the R-2670 Communication Analyzer

<b>1</b>	Connect a BNC cable between the “DEMOD OUT” port and the “VERT/SINAD DIST/DMM COUNTER IN” port on the R-2670.
<b>2</b>	Press the <b>SPF</b> key on the R-2670 to display the SPECIAL FUNCTIONS menu. Move the cursor to High Pass, and select <b>5 Hz</b> via the soft key menu. Select <b>20 kHz</b> for the Low Pass setting.
<b>3</b>	In the RF Control section of the R-2670 enter the frequency displayed on the RSS screen (choose a test frequency from the list of frequencies displayed under Transmit Deviation balance (Compensation) in RSS). Move the cursor to the B/W setting and select <b>WIDE +/- 100 kHz</b> via the soft key menu.
<b>4</b>	Place the R-2670 cursor in the Display zone. Select <b>AC VOLTS</b> on the soft key menu. Move the cursor to the Range setting and select <b>AUTO</b> .
<b>5</b>	Continue with RSS or CPS procedure listed below.

Use the following procedure for initial setup using an 8900 Series Modulation Analyzer.

**Procedure 7-8 Initial Setup Using the 8900 Series Modulation Analyzer**

<b>1</b>	Press the <b>FM Measurement</b> button. (Error 03-input level too low. This indication is normal until an input signal is applied).
<b>2</b>	Simultaneously press the <b>Peak-</b> and <b>Peak +</b> buttons. Both LEDs on the buttons should be lit.
<b>3</b>	Press the <b>15kHz LP Filter</b> button. Continue with RSS or CPS procedure below.

## 7.4.1 RSS and CPS Procedures

Use the following RSS procedure when applicable.

**Procedure 7-9 RSS Procedure**

<b>1</b>	From the TRANSMITTER ALIGNMENT menu press <b>F4</b> to select the Transmit Deviation Balance (Compensation) alignment screen.
<b>2</b>	Use the <b>Tab</b> key to select and to start alignment at the lowest frequency listed. Press <b>F4</b> to key the radio (80 Hz low tone). Wait approximately 5 seconds until the frequency displayed on the analyzer settles.
<b>3</b>	Measure and record the deviation value from the 8901B analyzer or the AC voltage value from the R2670
<b>4</b>	Press <b>F4</b> to dekey the radio.
<b>5</b>	Press <b>F6</b> to key the radio (3 kHz high tone). Wait approximately 5 seconds until the deviation (8901B)/voltage (R2670) displayed on the analyzer settles.
<b>6</b>	Use the computer UP/DOWN arrow keys to adjust the deviation/voltage to within +/- 1.5% of the value recorded for the 80 Hz low tone above (the goal is to adjust the deviation/voltage of the “3 KHz high tone” injection as close as possible to that of the “80 Hz low tone” injection).
<b>7</b>	Press <b>F6</b> to de-key the radio.
<b>8</b>	Press <b>F8</b> to program the new softpot value.
<b>9</b>	Repeat steps 3-8 for each of the remaining frequencies. Note – test frequency #7 (ex. 519.9750 MHz for UHF Range 2) is not normally used and therefore does not require alignment.
<b>10</b>	Press <b>F10</b> once to return to the TRANSMITTER ALIGNMENT menu.

Use the following CPS procedure when applicable.

**Procedure 7-10** CPS Procedure

<b>1</b>	Under the TRANSMITTER ALIGNMENTS menu, double click on <b>TX Deviation Balance (Compensation)</b> to select it. The screen will indicate the transmit frequencies to be used.
<b>2</b>	Select the desired frequency field (starting with the lowest frequency shown on the top of the screen).
<b>3</b>	Select the <b>PTT Tone: Low</b> button.
<b>4</b>	Select the <b>PTT</b> toggle button on the screen to make the radio transmit. The screen indicates whether the radio is transmitting. Wait approximately 5 seconds until the deviation (8901B)/voltage (R2670) displayed on the analyzer settles.
<b>5</b>	Measure and record the deviation/voltage value from the 8900 series analyzer or the AC voltage value from the R2670.
<b>6</b>	Select the <b>PTT</b> toggle button on the screen to stop transmitting.
<b>7</b>	Select the <b>PTT Tone: High</b> button.
<b>8</b>	Adjust the softpot value until the measured deviation/voltage, when using the high tone, is within +/- 1.5% of the value recorded in step 5 (the Low tone value).
<b>9</b>	Select the <b>PTT</b> toggle button on the screen to stop transmitting.
<b>10</b>	Select the <b>PTT</b> toggle button again to verify the deviation setting.
<b>11</b>	Select the <b>Program</b> button to program the new softpot value. Repeat steps 3-10 to ensure the correct deviation balance value has been saved.
<b>12</b>	Repeat steps 3-11 for each of the remaining frequencies. Note – test frequency #7 (ex. 519.9750 MHz for UHF Range 2) is not normally used and therefore does not require alignment.
<b>13</b>	Select the <b>Close</b> button on the screen to return to the TRANSMITTER ALIGNMENTS menu.

## 7.5 Transmit Deviation Limit Alignment

This test can be done with either the R-2670 communication Analyzer or the 8900 series Modulation Analyzer. The method of choice is the R-2670.



Use the following procedure for initial setup using an R-2670 Communication Analyzer.

**Procedure 7-11 Initial Setup Using the R-2670 Communication Analyzer**

<b>1</b>	Connect a BNC cable between the DEMOD OUT port and the VERT/SINAD DIST/DMM COUNTER IN port of the R-2670.
<b>2</b>	Press the <b>SPF</b> key on the R-2670 to display the SPECIAL FUNCTIONS menu. Move the cursor to High Pass, and select <b>5 Hz</b> via the soft key menu. Select <b>20 kHz</b> for the Low Pass setting.
<b>3</b>	In the RF Control section of the R-2670 enter the frequency displayed on the RSS screen (choose a test frequency from the list of frequencies displayed under TRANSMIT DEVIATION LIMIT screen in RSS). Move the cursor to the B/W setting and select <b>WIDE +/- 100 kHz</b> via the soft key menu.
<b>4</b>	Place the R-2670 cursor in the Display zone. Move the cursor to the Meter setting and select <b>AC VOLTS</b> via the soft key menu. Move the cursor to the Range setting and select <b>AUTO</b> .

Use the following procedure for initial setup using an 8901B Modulation Analyzer.

**Procedure 7-12 Initial setup using the 8901B Modulation Analyzer**

<b>1</b>	Press the <b>FM Measurement</b> button. (Error 03-input level too low. This indication is normal until an input signal is applied).
<b>2</b>	Simultaneously press the <b>Peak –</b> and <b>Peak +</b> buttons. Both LEDs on the buttons should be lit.
<b>3</b>	Press the <b>15 KHz LP</b> filter button
<b>4</b>	Continue with RSS or CPS procedure below.

## 7.5.1 RSS and CPS Procedures

Follow the procedure below for using RSS.

**Procedure 7-13 Procedure Using RSS**



<b>1</b>	From the TRANSMITTER ALIGNMENT menu press <b>F5</b> to select the TRANSMIT DEVIATION LIMIT alignment screen.
<b>2</b>	Press <b>Tab</b> to select and to start alignment at the lowest frequency listed.
<b>3</b>	Press <b>F6</b> and observe the measurement. Wait approximately 5 seconds until the deviation (8901B)/voltage (R2670) displayed settles.
<b>4</b>	Adjust the deviation limit to within 0.158 to 0.163 VAC on the R-2670 (2.785 to 2.885 kHz on the 8901B). The optimum setting is 0.160 VAC (2.83 kHz).
<b>5</b>	Press <b>F6</b> to dekey the radio.
<b>6</b>	Press <b>F8</b> to program the new softpot value.

**Procedure 7-13** Procedure Using RSS (Continued)

<b>7</b>	Repeat steps 2-6 for the remaining frequencies. Note – test frequency #7 (ex 519.9750 MHz for UHF Range 2) is not normally used and therefore does not require alignment.
	 <div style="background-color: #00AEEF; color: white; padding: 2px 5px; display: inline-block;"><b>NOTE</b></div> <p style="text-align: center;">If the transmit limit adjustment required was excessive, repeat or recheck the transmit deviation balance compensation procedure.</p>
<b>8</b>	Press <b>Escape</b> button to return to MAIN menu.

Follow the procedure below for using CPS.

**Procedure 7-14** Procedure Using CPS

<b>1</b>	Double-click to select the TX DEVIATION LIMIT under the TRANSMITTER ALIGNMENT menu. The screen will indicate the transmit frequencies to be used.
<b>2</b>	Select the desired frequency field (starting with the lowest frequency shown on the top of the screen).
<b>3</b>	Select the <b>PTT</b> toggle button on the screen to make the radio transmit. The screen indicates whether the radio is transmitting. Wait approximately 5 seconds until the deviation/voltage displayed on the analyzer settles.
<b>4</b>	Adjust the deviation limit to within 0.158 to 0.163 VAC on the R-2670 (2.785 to 2.885 kHz). The optimum setting is 0.160 VAC (2.83 kHz).
<b>5</b>	Select the <b>PTT</b> toggle button on the screen to stop transmitting.
<b>6</b>	Select the <b>Program</b> button on the screen to save the tuned values. Repeat steps 3-5 to ensure the correct deviation limit value is saved.
<b>7</b>	Repeat steps 2-6 for the remaining frequencies.
	 <div style="background-color: #00AEEF; color: white; padding: 2px 5px; display: inline-block;"><b>NOTE</b></div> <p style="text-align: center;">Test frequency #7 (ex 519.9750 MHz for UHF Range 2) is not normally used and therefore does not require alignment.</p>
	 <div style="background-color: #00AEEF; color: white; padding: 2px 5px; display: inline-block;"><b>NOTE</b></div> <p style="text-align: center;">If the transmit limit adjustment required was excessive, repeat or recheck the transmit deviation balance compensation procedure.</p>
<b>8</b>	Select the <b>Close</b> button on the screen to return to the TRANSMITTER ALIGNMENTS menu.

## 7.6 Front End Filter Alignment (VHF and UHF only)

This procedure is only required for tuning the front-end filter varactors in the VHF and UHF models. The 800 MHz models utilize a fixed front-end filter.



**NOTE**

- IMPORTANT notes for proper Front End Filter alignment:
  - XTS 3000 VHF (H09Kxxxxxxx) radios equipped with transceiver board NLD8898K or later version has softpot tuning range of 128 – 255. Use only softpot values between 128 and 255 to perform Front End Filter alignment for all test frequencies identified in the Front End Filter alignment screen in RSS or CPS tuner. Doing otherwise will cause poor sensitivity performance when the radio is deployed in the field.
  - Whenever a controller board of a XTS 3000 VHF (H09Kxxxxxxx) radio is replaced it is necessary to identify the transceiver board version for proper Front End Filter alignment. It is recommended that the version of the transceiver board be identified before reassemble the radio.

Use the following procedure to identify transceiver board version.

**Procedure 7-15** How to Identify Transceiver Board Version

<b>1</b>	Use RSS or CPS Tuner and select RECEIVER ALIGNMENTS menu. Select <b>Front End Filter</b> alignment. The screen will indicate the receive frequencies at which the filter is to be aligned.
<b>2</b>	Set the RF test generator to the first receive frequency. Set the RF level at the radio standard antenna port to 4.0 Volts with no modulation.
<b>3</b>	Starting at a softpot value of 0, adjust <b>UP</b> until peak value of RSSI is found  <div style="display: flex; align-items: center;"> <div style="background-color: #00a0e3; color: white; padding: 2px 5px; font-weight: bold;">NOTE</div> </div> <p style="margin-left: 40px;">Read RSSI button (CPS) / F4 (RSS) must be selected to obtain each RSSI reading after adjustment, write down the peak value of RSSI.</p>
<b>4</b>	Go to a softpot value of 128 and adjust UP to see if another RSSI peak value for the same frequency is found.
<b>5</b>	If a new peak value that is close to a peak value found in previous step is found, the radio is equipped with revision NLD8898K or newer transceiver board.
<b>OR</b>	If no new peak value that is close to a peak value found in previous step is found, the radio is equipped with revision NLD8898H or older transceiver board.

## 7.6.1 RSS and CPS Procedures

Continue with RSS or CPS procedure below.

Use the following RSS procedure when applicable.

### Procedure 7-16 Procedure Using RSS

<b>1</b>	From the SERVICE menu, press <b>F3</b> to select the RECEIVER ALIGNMENT menu.
<b>2</b>	Press <b>F2</b> to select the FRONT END FILTER ALIGNMENT screen. The screen will indicate the receive frequencies at which the filter is to be aligned.
<b>3</b>	Press <b>Tab</b> key (or <b>Enter</b> or <b>Return</b> ) to select a frequency field.
<b>4</b>	Set the RF test generator to the first receive frequency. Set the RF level at the radio standard antenna port to <b>4.0uV</b> with no modulation.
<b>5</b>	Adjust the <b>Up/Down</b> arrow keys to obtain a peak value in the RSSI (Receive Signal Strength Indicator) field.
	 <p style="text-align: center;"><b>NOTE</b></p> <p style="text-align: center;"><b>F4</b> must be pressed to obtain each RSSI reading after adjustment.</p>
<b>6</b>	Adjust the <b>Down</b> arrow key until the RSSI peak value drops 5 points and record the softpot value. If the softpot value reaches its tuning range limit, record that softpot value.
<b>7</b>	Adjust the <b>Up</b> arrow key until the RSSI peak value drops 5 points and record the softpot value. If the softpot value reaches its tuning range limit, record that softpot value.
<b>8</b>	Set the softpot value midway between the softpot values recorded in step 6 and step 7.
<b>9</b>	Press <b>F8</b> to program the new softpot value.
<b>10</b>	Repeat steps 3-9 for the remaining frequencies.
<b>11</b>	Press <b>F10</b> once to return to the RECEIVER ALIGNMENT menu, or press <b>F10</b> twice to return to the SERVICE menu.

Use the following CPS procedure when applicable.

### Procedure 7-17 Procedure Using CPS

<b>1</b>	Under the RECEIVER ALIGNMENTS menu, select FRONT END FILTER. The screen will indicate the receive frequencies at which the filter is to be aligned.
<b>2</b>	Select a frequency field (starting with the lowest frequency shown).
<b>3</b>	Set RF test generator to the first receive frequency. Set the RF level at the radio standard antenna port to <b>4.0uV</b> with no modulation.

**Procedure 7-17** Procedure Using CPS (Continued)

<b>4</b>	Adjust the <b>Up/Down</b> arrow keys under New Softpot Value window to obtain a peak value in the RSSI (Receive Signal Strength Indicator) field.
	 <div style="display: inline-block; background-color: #00AEEF; color: white; padding: 2px 5px; margin-left: 10px;"><b>NOTE</b></div> <p style="margin-left: 40px;">Read RSSI button must be selected to obtain each RSSI reading after adjustment.</p>
<b>5</b>	Adjust the <b>Down</b> arrow key until the RSSI peak value drops 5 points and record the softpot value. If the softpot value reaches its tuning range limit, record that softpot value.
<b>6</b>	Adjust the <b>Up</b> arrow key until the RSSI peak value drops 5 points and record the softpot value. If the softpot value reaches its tuning range limit, record that softpot value.
<b>7</b>	Set the softpot value midway between the softpot values recorded in step 5 and step 6.
<b>8</b>	Select <b>Program</b> button to program the new softpot value.
<b>9</b>	Repeat steps 2-8 for the remaining frequencies.
<b>10</b>	Select the <b>Close</b> button to return to the RECEIVER ALIGNMENTS menu.

## 7.7 Bit Error Rate Testing

Use the following procedure for initial setup using an R-2670 Communication Analyzer.

### Procedure 7-18 R2670 (Communication Analyzer) Setup

<b>1</b>	Connect the RF Input port of the radio under test to the RF IN/OUT port of the R2670 Service Monitor.
<b>2</b>	<p>Setup for <b>R2670 Service Monitor</b>:</p> <ol style="list-style-type: none"> <li><b>1.</b> In the <b>Display Zone</b>, select PROJ 25 STD mode and set the meter to RF DISPLAY.</li> <li><b>2.</b> In the RF Zone configure the analyzer as follows:  <b>RF control:</b> Generate  <b>Preset:</b> B/W: NB  <b>Freq:</b> Test frequency (ex: 851.0625 MHz)  <b>Output Level</b> -50.0 dBm  <b>Gen RF Out</b> RF I/O</li> <li><b>3.</b> In the Audio Zone, select the <b>1011 Hz PAT</b> code and set the deviation to <b>PROJ25Dev: 2.83 kHz ~</b>.</li> </ol>

Use the following RSS procedure when applicable.

### Procedure 7-19 Procedure Using RSS

<b>1</b>	<p>Configure the radio under test to the BER Test mode - this can be done through RSS as follows:</p> <ol style="list-style-type: none"> <li><b>1.</b> From the MAIN Menu in RSS, press <b>F2</b> to select SERVICE ALIGNMENT.</li> <li><b>2.</b> Press <b>F5</b> to select PERFORMANCE TESTING.</li> <li><b>3.</b> Press <b>F2</b> to select BIT ERROR RATE. Enter the test frequency in the Rx Frequency (MHz) field (ex. 851.0625MHz) and select desired Modulation type as <b>12.5kHz/C4FM</b>. Set BER Integration Time (sec) to minimum of <b>7.2 sec</b>.</li> <li><b>4.</b> Press <b>F6</b> (START/STOP) to start the test.</li> </ol>
<b>2</b>	Monitor the radio's received BER(%). Reduce the analyzer's output level to achieve standard Bit Error Rate of 5%. Reference sensitivity is the analyzer's RF output level. Reference sensitivity at 5% Bit Error Rate should be -116 dBm or less. Note that 5% BER is equivalent to 12 dB Sinad.

# Basic Removal/Installation Procedures

---

This section gives basic procedures for removing and installing the following XTS 3000 radio components:

- "Antenna"
- "Battery"
- "Belt Clip"
- "Universal Connector Cover"
- "Frequency Knob"
- "Volume Knob"

## 8.1 Antenna

---

The following sections explain installation and removal of the antenna.

### 8.1.1 Installing the Antenna

Screw the threaded end of the antenna into the antenna receptacle on the top of the radio. Rotate the antenna clockwise until it seats firmly against the bushing.

### 8.1.2 Removing the Antenna

Rotate the antenna counterclockwise until its threaded end unscrews from the radio's antenna receptacle.

## 8.2 Battery

---



### NOTE

The battery is shipped uncharged, and must be charged before use.



### WARNING

**To avoid a possible explosion:**

- **DO NOT** replace the battery in an area labeled “hazardous atmosphere.”
- **DO NOT** discard batteries in a fire.



### CAUTION

**If your radio is programmed with volatile-key retention (consult your service technician), encryption keys will be retained for approximately 30 seconds after battery removal.**



## 8.2.1 Installing the Battery

Use the following procedure to install the battery.

### Procedure 8-1 Battery Installation

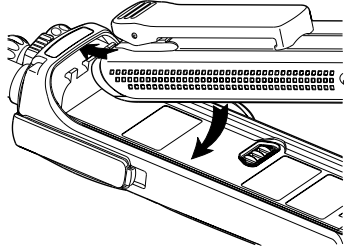
1	Turn off the radio and hold it with the back of the radio facing upward.
2	<p>Insert the top edge of the battery into the area at the top of the radio between the radio's case and chassis. Make sure the three tabs on the radio chassis align with the three slots under the top edge of the battery.</p> 
3	Rotate the battery toward the radio, and squeeze the battery and radio together until the battery clicks in place.

## 8.2.2 Removing the Battery

Use the following procedure to remove the battery.

### Procedure 8-2 Battery Removal

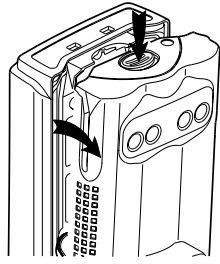
1	Turn off the radio and hold it so that the release button on the bottom of the battery is facing upward.
2	<p>Press downward on the release button so the battery disengages from the radio.</p> 
3	Remove the battery completely away from the radio.

## 8.3 Belt Clip

This section describes how to install and remove the belt clip.



### NOTE

The battery must be removed from the radio before the belt clip can be installed or removed.

### 8.3.1 Installing the Belt Clip

Use the following procedure to install the belt clip.

#### Procedure 8-3 Belt Clip Attachment

<b>1</b>	Hold the battery in one hand so that the top of the battery faces upward, and the back of the battery faces you.
<b>2</b>	Holding the belt clip in the other hand with its top facing upward, align the slide assembly on the front of the belt clip with the slots on the back of the battery.
<b>3</b>	Slide the belt clip downward toward the bottom of the battery until the belt clip “clicks” in place.

## 8.3.2 Removing the Belt Clip

Use the following procedure to remove the belt clip.

### Procedure 8-4 Belt Clip Removal

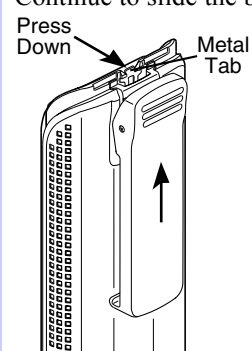
1	Hold the battery (with belt clip installed) in one hand so that the top of the battery faces upward, and the front (radio side) of the battery faces you.
2	At the top of the battery, press down on the belt clip's metal tab and slide the belt clip upward until it disengages from the battery.
3	<p>Continue to slide the belt clip upward until it is free from the battery.</p> 

## 8.4 Universal Connector Cover



### CAUTION

When the universal connector is not in use, keep it covered with the universal connector cover.

## 8.4.1 Installing the Universal Connector Cover

Use the following procedure to install the universal connector cover.

### Procedure 8-5 Universal Connector Cover Installation

<b>1</b>	Looking at the antenna side of the radio, insert the top (flat) hooked end of the cover into the slot on the top of the radio, above the universal connector. Press downward on the cover's top to seat it in the slot.
<b>2</b>	While holding the cover's top (flat) end in place with your thumbs, pry upward on the cover's lower end until it disengages from the radio.

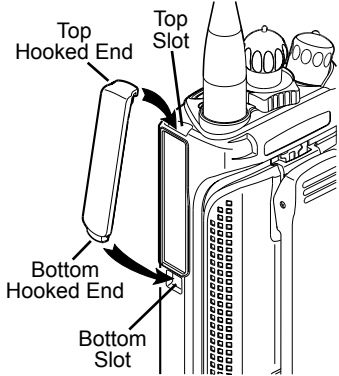

## 8.4.2 Removing the Universal Connector Cover

Use the following procedure to remove the universal connector cover.

### Procedure 8-6 Universal Connector Cover Removal

<b>1</b>	Looking at the antenna side of the radio, insert a flat-bladed screwdriver into the area between the lower end of the universal connector cover and the slot below the universal connector.
<b>2</b>	Pry upward on the cover's lower end until it disengages from the radio.

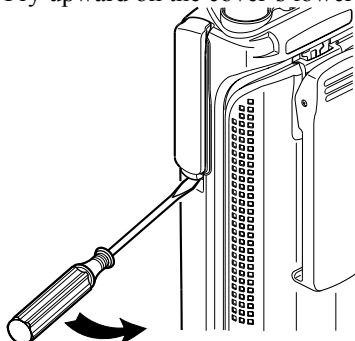

## 8.5 Frequency Knob

Refer to [Figure 8-1](#), the Partial Exploded View, and [Table 8-1](#), the Partial Exploded View Parts List. Numbers in parentheses ( ) refer to item numbers in [Figure 8-1](#) and [Table 8-1](#).



### NOTE

- The battery (7) should be removed from the radio before installing or removing the frequency knob (1).
- In cases where the frequency insert (3) and escutcheon (2) must be removed, a new frequency insert and new escutcheon **must** be used for reassembly.

### 8.5.1 Installing the Frequency Knob

Use the following procedure to install the frequency knob.

#### Procedure 8-7 Frequency Knob Installation

<b>1</b>	Hold the radio so that the top of the radio faces upward, and the front of the radio faces you.
<b>2</b>	Align the lightpipe (5) so that its straight tab is over the slot for the illuminated pointer. Push the tab down into the slot so that it is securely seated.
<b>3</b>	Place the secure lever (4) on the frequency control shaft, aligning it so that its pointer is at the front of the radio and its two inner slots line up with the two keys on the shaft. Slide the secure lever down to the bottom of the shaft.
<b>4</b>	If you are replacing the escutcheon (2), remove the backing paper from the escutcheon, align its alignment marker with the alignment notch (between numbers 4 and 5) on the insert, and adhere it to the insert.
<b>5</b>	Place a new frequency insert (3) and new escutcheon (2) on the frequency control shaft, aligning the insert's D-shaped hole with the D-shaped shaft. Press downward firmly on the insert until it "snaps" in place on the shaft.
	Place the frequency knob (1) on the frequency insert (3), aligning its pointer with the number "1" on the escutcheon (2). Press firmly downward on the knob until it seats securely in place.

## 8.5.2 Removing the Frequency Knob

Use the following procedure to remove the frequency knob.

### Procedure 8-8 Frequency Knob Removal

<b>1</b>	Hold the radio in one hand so that the top of the radio faces upward, and the front of the radio faces you.
<b>2</b>	With the other hand, grasp the frequency knob (1) and pull it upward, while pushing it toward the back of the radio, until it is free from the frequency insert (3).
<b>3</b>	While pressing the insert's (3) two snap tabs away from the frequency control shaft so that the insert disengages from the shaft, use needle-nosed pliers to lift the insert up and off of the frequency control shaft.
<b>4</b>	Remove the secure lever (4) and the lightpipe (5).

## 8.6 Volume Knob



### NOTE

- Refer to [Figure 8-1](#), the Partial Exploded View, and [Table 8-1](#), the Partial Exploded View Parts List. Numbers in parentheses ( ) refer to item numbers in [Figure 8-1](#) and [Table 8-1](#).
- The battery (7) should be removed from the radio before installing or removing the volume knob (8).
- In cases where the volume insert (9) must be removed, a new volume insert **must** be used for reassembly.

## 8.6.1 Installing the Volume Knob

Use the following procedure to install the volume knob.

### Procedure 8-9 Volume Knob Installation

1	Place the O-ring (21) inside the volume insert (9), and press it downward until it seats securely at the bottom of the insert.
2	Hold the radio so that the top of the radio faces upward, and the front of the radio faces you.
3	Place a new volume insert (9) on the volume control shaft, aligning the insert's D-shaped hole with the D-shaped shaft. Press downward firmly on the insert until it "snaps" in place on the shaft.
4	Place the volume knob (8) on the volume insert (9), aligning the two lugs on the inside of the knob with the insert's two snap tabs. Press firmly downward on the knob until it seats securely in place.

## 8.6.2 Removing the Volume Knob

Use the following procedure to remove the volume knob.

### Procedure 8-10 Volume Knob Removal

1	Hold the radio in one hand so that the top of the radio faces upward, and the front of the radio faces you.
2	With the other hand, grasp the volume knob (8) and pull it upward, while pushing it toward the back of the radio, until it is free from the volume insert (9).
3	While pressing the volume insert's (9) two snap tabs away from the volume control shaft so that the insert disengages from the shaft, use needle-nosed pliers to pull the insert up and off of the volume control shaft.
4	Using needle-nosed pliers or some other pointed instrument, remove the O-ring (21).

## 8.7 Partial Exploded View and Parts List

Figure 8-1 Partial Exploded View

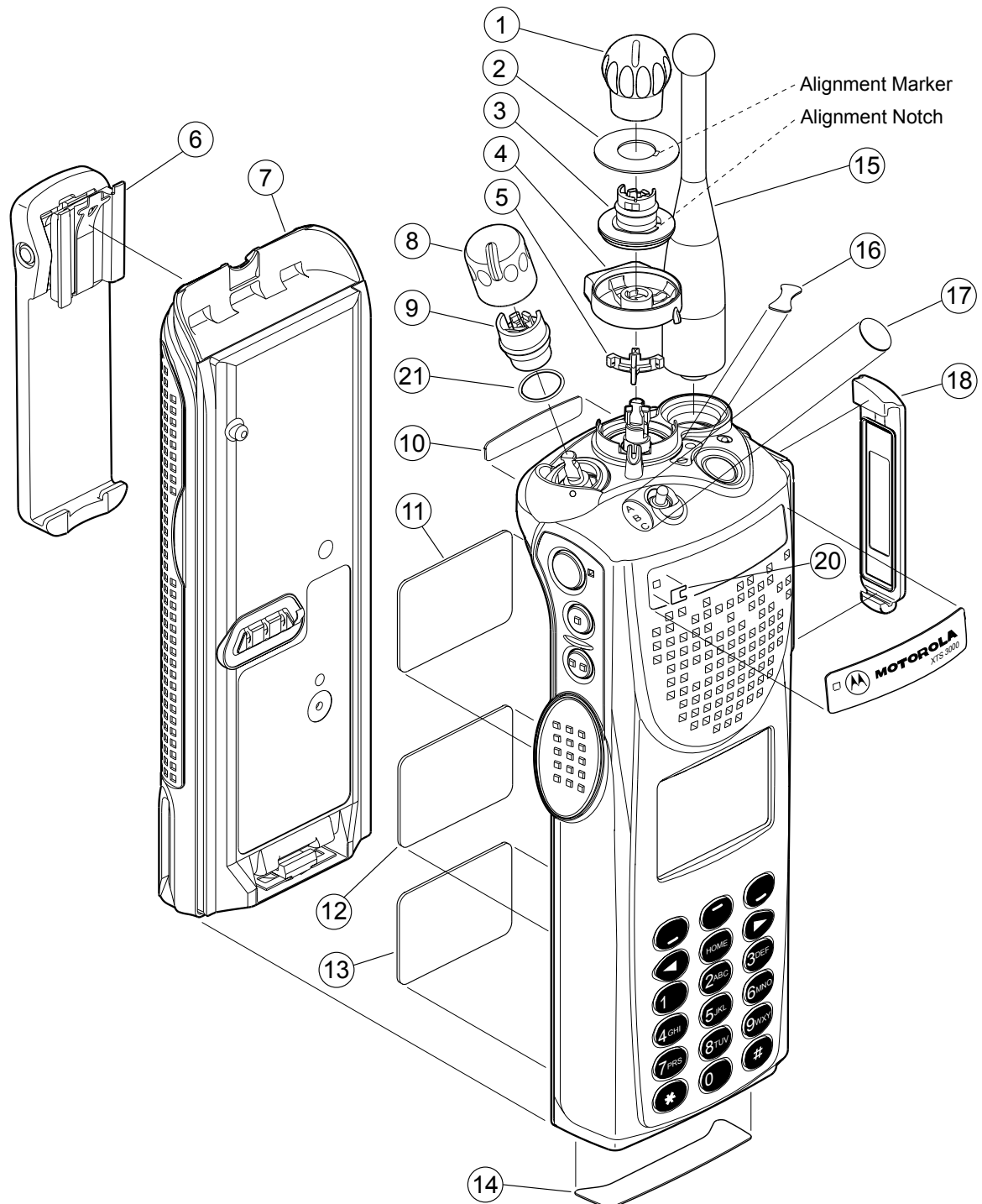



A parts list for the Partial Exploded View is contained below.

**Table 8-1** Partial Exploded View Parts List

Item No.	Motorola Part No.	Description
1	3605370Z01	KNOB, Frequency
2	1305374Z03	ESCUTCHEON, Frequency
3	4305373Z02	INSERT RETAINER, Frequency Knob
4	4305375Z01	LEVER, Secure Frequency
5	6105376Z01	LIGHTPIPE INDICATOR/STOP, Frequency
6	NTN8266A	CLIP, Belt
7	NTN8298A	Battery, NiCd
8	3605371Z01	KNOB, Volume
9	4305372Z01	INSERT RETAINER, Volume Knob
10	3305574Z01	LABEL, Motorola, Back
11	-----	LABEL, Flashport
12	-----	LABEL, Radio Serial Number
13	-----	LABEL, Approval Agency
14	3305630Z02	LABEL, Bottom
15	NAF5037A or NAF5039A or NAF5042A	ANTENNA, 800 MHz Whip (806-870 MHz) ANTENNA, 800 MHz Dipole (806-870 MHz) ANTENNA, 800 MHz Stubby Quarterwave (806-870 MHz)
16	3385657D01 3385657D02	LABEL, ABC, Black Housing (optional — need if housing is not pad printed.) LABEL, ABC, Yellow Housing (optional — need if housing is not pad printed.)
17	3385658D01 3385658D02	LABEL, Toggle, Black Housing (optional — need if housing is not pad printed) LABEL, Toggle, Yellow Housing (optional — need if housing is not pad printed)
18	1505579Z01	COVER, Dust, Universal Connector
19	3385619B01 3385619B02 3385619B03	LABEL, Motorola, Front (Standard) LABEL, Motorola, Front (Ruggedized) LABEL, Motorola, Front (Ruggedized, Yellow)
20	3505586Z01	Gortex
21	3205379W01	O-Ring

**This page intentionally left blank.**

# Theory of Operation

---

## 9.1 General Overview

---

The ASTRO Digital XTS 3000 radio is a wideband, synthesized, fixed-tuned radio available in the 800 MHz band. All ASTRO Digital XTS 3000 radios are capable of both analog operation and ASTRO mode (digital) operation in 12.5 kHz or 25 kHz bandwidths.

The ASTRO Digital XTS 3000 radio includes the following major assemblies:

- Controller Board - contains the microcontrol unit (MCU) and its associated memory and memory management integrated circuit (IC), the audio power amplifier, and a switching regulator.
- RF Board - contains all transmit, receive, and frequency generation circuitry including the digital receiver back-end IC and the reference oscillator.
- Vocoder Board - contains the digital signal processor (DSP) and its support IC and associated memories.
- Controls/Universal Flex - contains volume/on/off switch, frequency selector switch, push-to-talk (PTT) button, monitor button, several function-selectable switches, universal connector, speaker, and microphone.
- Display (Models II and III only) - a four-line, 12-character liquid crystal display (LCD).
- Keypad (Models II and III only) - Model II — a 3x2 keypad; Model III — a 3 x 6 keypad.

## 9.2 Analog Mode of Operation

---

When the radio is receiving, the signal comes from the antenna connector to the RF board, passes through the RX/TX switch and the receiver front end. The signal is then filtered, amplified, and mixed with the first local-oscillator signal generated by the voltage-controlled oscillator (VCO).

The resulting intermediate frequency (IF) signal is fed to the IF circuitry, where it is again filtered and amplified. This amplified signal is passed to the digital back-end IC, where it is mixed with the second local oscillator to create the second IF at 450 kHz. It is then converted to a digital bit stream and mixed a third time to produce a baseband signal. This signal is passed to the vocoder board through a current-driven differential output.

On the vocoder board, the digital- signal-processor-support IC digitally filters and discriminates the signal, and passes it to the digital-signal processor (DSP). The DSP decodes the information in the signal and identifies the appropriate destination for it. For a voice signal, the DSP will route the digital voice data to the DSP-support IC for conversion to an analog signal. The DSP-support IC will then present the signal to the audio power amplifier, which drives the speaker. For signalling information, the DSP will decode the message and pass it to the microcontrol unit.

When the radio is transmitting, microphone audio is passed from the audio power amplifier (PA) to the DSP-support IC, where the signal is digitized. The DSP-support IC passes digital data to the DSP, where pre-emphasis and lowpass (splatter) filtering are done. The DSP returns this signal to the DSP-support IC, where it is reconverted into an analog signal and scaled for application to the voltage-controlled oscillator as a modulation signal.

Transmitted signalling information is accepted by the DSP from the microcontrol unit, coded appropriately, and passed to the DSP-support IC, which handles it the same as a voice signal. Modulation information is passed to the synthesizer along the modulation line. A modulated carrier is provided to the RF PA, which transmits the signal under dynamic power control.

## 9.3 ASTRO Mode of Operation

---

In the ASTRO mode (digital mode) of operation, the transmitted or received signal is limited to a discrete set of deviation levels, instead of continuously varying. The receiver handles an ASTRO-mode signal identically to an analog mode signal up to the point where the DSP decodes the received data. In the ASTRO receive mode, the DSP uses a specifically defined algorithm to recover information.

In the ASTRO transmit mode, microphone audio is processed identically to an analog mode with the exception of the algorithm the DSP uses to encode the information. This algorithm will result in deviation levels that are limited to discrete levels.

## 9.4 RF Board Basic Theory of Operation

The receiver front end consists of a pre-selector, an RF amplifier, a second preselector, and a mixer. Both preselectors in the VHF and UHF radios are varactor-tuned, two-pole filters, controlled by the microcontroller unit through the digital/analog (D/A) IC. In the 800 MHz front end, both pre-selectors are two-pole, fixed-tuned filters. The RF amplifier is a dual-gate, gallium-arsenide-based IC. The mixer is a double-balanced, active mixer coupled by transformers. Injection is provided by the VCO through an injection filter. See [Table 9-1](#) for local oscillator (LO) and first IF information.

**Table 9-1** Local Oscillator and First IF Frequencies

	VHF	UHF	800 MHz
LO Frequency Range	181.15–223.15 MHz	329.65–446.65 MHz	732.65–796.65 MHz
First IF Frequency	45.15 MHz	73.35 MHz	73.35 MHz

The frequency generation function is performed by three ICs and associated circuitry. The reference oscillator provides a frequency standard to the synthesizer/prescaler IC, which controls the VCO IC. The VCO IC actually generates the first LO and transmit-injection signals and buffers them to the required power level. The synthesizer/prescaler circuit module incorporates frequency-division and comparison circuitry to keep the VCO signals stable. The synthesizer/prescaler IC is controlled by the microcontrol unit through a serial bus. Most of the synthesizer circuitry is enclosed in rigid metal cans on the RF board to reduce microphonic effects.

The receiver back end consists of a two-pole crystal filter, an IF amplifier, a second two-pole crystal filter, and the digital back-end IC. The two-pole filters are wide enough to accommodate 5 kHz modulation. Final IF filtering is done digitally in the DSP-support IC.

The digital back-end IC consists of an amplifier, the second mixer, an IF analog-to-digital converter, a baseband down-converter, and a 2.4 MHz synthesis circuit to provide a clock to the DSP-support IC on the vocoder board. The second LO is generated by discrete components external to the IC. The output of the digital back-end IC is a digital bit stream that is current driven on a differential pair for a reduction in noise generation.

The transmitter consists of an RF PA IC that gets an injection signal from the VCO. Transmit power is controlled by two custom ICs that monitor the output of a directional coupler and adjust PA control voltages correspondingly. The signal passes through a RX/TX switch that uses PIN diodes to automatically provide an appropriate interface to transmit or receive signals. Antenna selection is done mechanically in the control top.

## 9.5 Controller Board Basic Theory of Operation

The controller board contains the radio's microcontrol unit with its memory and support circuits, voltage regulators, audio, and power control circuits. Connected to the controller board are the display board, RF board, vocoder board, keypad board, controls/universal flex, and (optional) encryption module.

The microcontrol unit controls receive/transmit frequencies, power levels, display, and other radio functions, using either direct logic control or serial communications paths to the devices. The microcontrol unit executes a stored program located in the FLASH ROM. Data is transferred to and from memory by the microcontrol unit data bus. The memory location from which data is read, or to which data is written, is selected by the address lines.

The support-logic IC acts as an extension of the microcontrol unit by providing logic functions such as lower address latch, reset, memory address decoding, and additional control lines for the radio. The microcontrol unit controls the crystal-pull circuit to adjust the crystal oscillator's frequency on the microcontrol unit, so that the E-clock's harmonics do not cause interference with the radio's receive channel.

The regulator and power-control circuits include an unswitched +5V discrete circuit and the regulator/power-control IC. Switched +5V is used for all circuits on the controller board except the audio PA, which is sourced from 7.5V. The regulator automatically provides 5V when the radio is turned on. The regulator's power-down mode is controlled by the microcontrol unit, which senses the position of the on/off switch.

## 9.6 Vocoder Board Basic Theory of Operation

---

The vocoder board contains the digital-signal processor (DSP), its memory devices, and the DSP-support IC.

The DSP performs signalling and voice encoding and decoding as well as audio filtering and volume control. This IC performs Private-Line®/ Digital Private Line™ (PL/DPL) encode and alert-tone generation. The IC transmits pre-emphasis on analog signals and applies a low-pass (splatter) filter to all transmitted signals. It requires a 33 MHz crystal to function. An 8 kHz interrupt signal generated by the DSP-support IC is also required for functionality. It is programmed using parallel programming from the microcontrol unit and the DSP-support IC.

The DSP-support IC performs analog-to-digital and digital-to-analog conversions on audio signals. It contains attenuators for volume, squelch, deviation, and compensation, and it executes receiver filtering and discrimination. The IC requires a 2.4 MHz clock to function (generated by the digital back-end IC) and is programmed by the microcontrol unit SPI bus.

# Troubleshooting

This section of the manual contains troubleshooting charts and error codes that will help you to isolate a problem. Level one troubleshooting will support only radio alignment, programming, battery replacement, and knob replacement. If the radio needs further troubleshooting, it must be sent to the depot.

Board- and component-level and service information can be found in the “ASTRO Digital XTS 3000 Portable Radios Detailed Service Manual,” Motorola publication number 68P81083C90.

## 10.1 Power-Up Error Codes

When the radio is turned on (power-up), the radio performs cursory tests to determine if its basic electronics and software are in working order. Problems detected during these tests are presented as error codes on the radio’s display. The presence of an error should prompt the user that a problem exists and that a service technician should be contacted.

Self-test errors are classified as either fatal or non-fatal. Fatal errors will inhibit user operation; non-fatal errors will not. Use Table 14 to aid in understanding particular power-up error code displays.

**Table 10-1** Power-Up Error Code Descriptions

Error Code	Description	Corrective Action
01/02	External EEPROM Checksum Non-Fatal Error	Reprogram codeplug.
01/81	ROM Checksum Failure	Send radio to depot.
01/82	External EEPROM Checksum Failure	Reprogram the codeplug.
01/84	SLIC Initialization Failure	Turn the radio off, then on.
01/88	RAM Failure - Note: not a checksum failure	Turn the radio off, then on.
01/90	General Hardware Failure	Turn the radio off, then on.
01/92	Internal EEPROM Checksum Failure	Reprogram the codeplug.
02/10	DSP support IC checksum Non-Fatal Error	Turn the radio off, then on.
02/81	DSP ROM Checksum Failure	Send radio to depot.
02/88	DSP RAM Failure - Note: not a checksum failure	Turn the radio off, then on.

**Table 10-1** Power-Up Error Code Descriptions (Continued)

Error Code	Description	Corrective Action
02/90	General DSP Hardware Failure (DSP startup message not received correctly)	Turn the radio off, then on.
02/A0	ADSIC Checksum Failure - Non-Fatal Error	Turn the radio off, then on.
09/10	Secure Hardware Failure	Send radio to depot.
09/90	Secure Hardware Failure	Send radio to depot.

**NOTE**

If the corrective action does not fix the failure, send the radio to the depot.

## 10.2 Operational Error Codes

---

During radio operation, the radio performs dynamic tests to determine if the radio is working properly. Problems detected during these tests are presented as error codes on the radio's display. The presence of an error code should prompt a user that a problem exists and that a service technician should be contacted. Use [Table 10-2](#) to aid in understanding particular operational error codes.

**Table 10-2** Operational Error Code Displays

Error Code	Description	Corrective Action
FAIL 001	Synthesizer Out-of-Lock	a. Reprogram codeplug b. Send radio to depot
FAIL 002	Selected Mode/Zone Codeplug Checksum Error	Reprogram codeplug



Below is the Receiver Troubleshooting Chart.

**Table 10-3** Receiver Troubleshooting Chart

Symptom	Possible Cause	Correction or Test (Measurements Taken at Room Temperature)
Radio Dead; Display Does Not Light Up	1. Dead Battery	Replace with charged battery.
	2. Blown Fuse	Send radio to depot.
	3. On/Off Switch	
	4. Regulators	
Radio Dead; Display Lights Up	1. Controller Board	Send radio to depot.
	2. RF Board	
No Receiver Audio or Receiver Does Not Unmute	Programming	a. Does the transmitted signal match the receiver configuration (PL, DPL, etc.) b. With the monitor function enabled, can the radio be unmuted?
Audio Distorted or Not Loud Enough	Synthesizer Not On Frequency	Check synthesizer frequency by measuring the transmitter frequency; if off by more than $\pm 250$ Hz, realign.
RF Sensitivity Poor	1. Synthesizer Not On Frequency	Check synthesizer frequency by measuring the transmitter frequency; if off by more than $\pm 600$ Hz, realign.
	2. Antenna Switch	Send radio to depot.
	3. Receiver Front- End Tuning (VHF/ UHF only)	Check RF front-end tuning for optimum sensitivity using the RSS.
Radio Will Not Turn Off	Controller Board	Send radio to depot.

Below is the Transmitter Troubleshooting Chart.

**Table 10-4** Transmitter Troubleshooting Chart

Symptom	Possible Cause	Correction or Test (Measurements Taken at Room Temperature)
No RF Power Out	1. TX Power Level or Frequency	Check TX power level and frequency programming (from RSS).
	2. No PTT From Control Top	Send radio to depot.
	3. No Injection To Power Amplifier	
No Modulation; Distorted Modulation	1. Programming	Check deviation and compensation settings using the RSS.
	2. Controller Board	Send radio to depot.
Bad Microphone Sensitivity	1. Check Deviation and Compensation	Realign if necessary.

**Table 10-4** Transmitter Troubleshooting Chart (Continued)

Symptom	Possible Cause	Correction or Test (Measurements Taken at Room Temperature)
	2. Microphone	Send radio to depot.
No/Low Signalling (PL, DPL, MDC)	1. Programming	Check Programming
	2. Controller Board	Send radio to depot.
Can't Set Compensation	RF Board	Send radio to depot.

Below is the Encryption Troubleshooting Chart.

**Table 10-5** Encryption Troubleshooting Chart

Symptom	Possible Cause	Corrective Action
No "KEYLOAD" on Radio Display When Keyloading Cable is Attached to the Radio Side Connector	1. Defective Keyload Cable	Send radio to depot.
	2. Defective Radio	
Keyloader Displays "FAIL."	1. Wrong Keyloader	Make Sure the Keyloader is a "T----CX" or "T----DX" Keyloader.
	2. Bad Keyloader	Try Another Keyloader
	3. Defective Radio	Send radio to depot.

**NOTE**

Keyloaders "T----AX" and "T----BX" must be upgraded to "T----CX" and "T----DX" in order to keyload an XTS 3000 radio.

# Glossary

---

**A/D** — Analog to Digital converter; converts an instantaneous dc voltage level to a corresponding digital value.

**Abacus IC** — Custom integrated circuit providing a digital receiver IF backend.

**ADSIC** — ABACUS/DSP Support IC; custom integrated circuit providing peripheral functions for the DSP.

**ALC** — Automatic Level Control; a circuit in the transmit RF path that controls RF power amplifier output, provides leveling over frequency and voltage, and protects against high VSWR.

**D/A** — Digital to Analog converter; converts a digital value to a corresponding dc voltage value.

**DTMF** — Dual Tone Multi-Frequency

**DPL** — Digital Private-Line™

**DSP** — Digital Signal Processor; microcontroller specifically tailored for signal processing computations. In this case refers specifically to Motorola DSP56001.

**Firmware** — Software or a software/hardware combination of computer programs and data, with a fixed logic configuration stored in a read-only memory; information can not be altered or reprogrammed.

**FGU** — Frequency Generation Unit

**FLASHPort™** — A Motorola term that describes the ability of a radio to change memory. Every FLASHport radio contains a FLASHport EEPROM memory chip that can be software written and rewritten to, again and again.

**Host** — Motorola HC11F1 microcontrol unit U204 (see MCU).

**Host Port** — Parallel memory mapped interface consisting of eight registers in the DSP56001.

**IC** — Integrated Circuit

**IMBE** — A sub-band, voice encoding algorithm used in ASTRO digital voice.

**ISW** — Inbound Signalling Word; data transmitted on the control channel from a subscriber unit to the central control unit.

**LSH** — Low Speed Handshake; 150 baud digital data sent to the radio during trunked operation while receiving audio.

**MCU** — MicroControl Unit

**MDC** — Motorola Digital Communications

**MISO** — Master In Slave Out; used by the slave device to send data to the master device.

**MOSI** — Master Out Slave In; used by the master device to send data to the slave device.

**OMPAC** — Over-Molded Pad-Array Carrier; a Motorola custom IC package, distinguished by the presence of solder balls on the bottom pads.

**Open Architecture** — A controller configuration that utilizes a microprocessor with extended ROM, RAM, and EEPROM.

**OSW** — Outbound Signalling Word; data transmitted on the control channel from the central controller to the subscriber unit.

**PC Board** — Printed Circuit board

**PL** — Private-Line® tone squelch; a continuous sub-audible tone that is transmitted along with the carrier.

**PLL** — Phase-Locked Loop; a circuit in which an oscillator is kept in phase with a reference, usually after passing through a frequency divider.

**PTT** — Push-To-Talk; the switch located on the left side of the radio which, when pressed, causes the radio to transmit.

**Registers** — Short-term data-storage circuits within the microcontrol unit or programmable logic IC.

**Repeater** — Remote transmit/receive facility that re-transmits received signals in order to improve communications coverage.

**RESET** — Reset line; an input to the microcontroller that restarts execution.

**RF PA** — Radio Frequency Power Amplifier

**RSS** — Radio Service Software

**RPT/TA** — RePeaTer/Talk-Around

**RX DATA** — Recovered digital data line.

**Signal Qualifier Mode** — An operating mode whereby the radio is muted but still continues to analyze receive data to determine RX signal type.

**SCI IN** — Serial Communication Interface INput line.

**SLIC** — Support-Logic IC; a custom gate array used to provide I/O and memory expansion for the microcontroller.

**Softpot** — Software potentiometer; a computer-adjustable electronic attenuator.

**Software** — Computer programs, procedures, rules, documentation, and data pertaining to the operation of a system.

**SPI** — Serial Peripheral Interface; how the microcontroller communicates to modules and ICs through the CLOCK and DATA lines.

**Squelch** — Muting of audio circuits when received signal levels fall below a predetermined value.

**SRAM** — Static-RAM chip used for volatile, program/data memory.

**SSI** — Synchronous Serial Interface on the DSP56001 consisting of six signals and used for an RX and TX modulated data interface to the ADSIC.

**Standby Mode** — An operating mode whereby the radio is muted but still continues to monitor data.

**System Central Controllers** — Main control unit of the trunked dispatch system; handles ISW and OSW messages to and from subscriber units (see ISW and OSW).

**System Select** — The act of selecting the desired operating system with the system-select switch (also, the name given to this switch).

**TOT** — Time-Out Timer; a timer that limits the length of a transmission.

**TSOP** — Thin Small-Outline Package

**UART** — Universal Asynchronous Receiver Transmitter. VOCON VOcoder/CONtroller board

**μC** — Microcontrol unit (see MCU).

**VCO** — Voltage-Controlled Oscillator; an oscillator whereby the frequency of oscillation can be varied by changing a control voltage.

**VCOB IC** — Voltage-Controlled Oscillator Buffer IC

**Vocoder** — VOice enCODER; the DSP-based system for digitally processing the analog signals, includes the capabilities of performing voice compression algorithms or voice encoding.

**VSELP** — Vector Sum Excited Linear Predictive coding; a voice encoding technique used in ASTRO digital voice.

**VSWR** — Voltage Standing Wave Ratio

**This page intentionally left blank.**

# Index

.....

.....

.....

.....

## A

.....

alignment marker . . . . . 8-7      ASTRO mode . . . . . 9-2

alignment notch . . . . . 8-7      audio power amplifier . . . . . 9-1

analog . . . . . 9-1

## C

.....

carrier squelch (CSQ) . . . . . 6-4      controller board . . . . . 9-3

codeplug . . . . . 7-3      Controller Board . . . . . 9-1

## D

.....

digital signal processor (DSP) . . . . . 9-1      digital-to-analog (D/A) . . . . . 7-3

digital-signal processor (DSP) . . . . . 9-2, 9-4      DSP-support IC . . . . . 9-3 to 9-4

## E

.....

Elastomer . . . . . 4-3      escutcheon . . . . . 8-7

electrostatic discharge (ESD) . . . . . 4-3

## F

.....

frequency control shaft . . . . . 8-7      frequency insert . . . . . 8-7

frequency generation circuitry . . . . . 9-1      frequency knob . . . . . 8-7 to 8-8

## I

.....

IBM personal computer (PC) . . . . . 7-1      intermediate frequency (IF) . . . . . 9-2

## L

.....

lightpipe . . . . . 8-7 to 8-8      local oscillator (LO) . . . . . 9-3

## M

---

<ul style="list-style-type: none"> <li>maintenance           <ul style="list-style-type: none"> <li>basic . . . . . 4-1</li> <li>inspection . . . . . 4-1</li> <li>handling precautions . . . . . 4-2</li> <li>preventive . . . . . 4-1</li> <li>cleaning . . . . . 4-1</li> </ul> </li> <li>memory management integrated circuit (IC) . . . . . 9-1</li> </ul>	<ul style="list-style-type: none"> <li><i>memory management integrated circuit (IC) (contd.)</i> <ul style="list-style-type: none"> <li>RSS . . . . . 9-1</li> <li>microcomputer . . . . . 6-3, 7-3</li> <li>microcontrol unit . . . . . 9-2, 9-4</li> <li>microcontrol unit (MCU) . . . . . 9-1</li> <li>Mode/Zone Selector Switch . . . . . 6-5</li> <li>Motorola Parts Division . . . . . 5-2</li> </ul> </li> </ul>
---	---

## P

---

<ul style="list-style-type: none"> <li>power amplifier (PA) . . . . . 9-2</li> <li>PTT Switch . . . . . 6-5</li> </ul>	<ul style="list-style-type: none"> <li>push-to-talk (PTT) button . . . . . 9-1</li> </ul>
--	---

## R

---

<ul style="list-style-type: none"> <li>radio interface box (RIB) . . . . . 7-1</li> <li>radio service software . . . . . 7-4           <ul style="list-style-type: none"> <li>RSS . . . . . 7-2</li> </ul> </li> <li>radio service software (RSS) . . . . . 7-1</li> <li>Radio Service Software User's Guide . . . . . 5-3</li> </ul>	<ul style="list-style-type: none"> <li>receive . . . . . 9-1</li> <li>receiver muting . . . . . 6-3</li> <li>reference oscillator . . . . . 7-3 to 7-4, 9-1, 9-3</li> <li>RF board . . . . . 9-1</li> <li>RF channel selection . . . . . 6-3</li> </ul>
---	---

## S

---

<ul style="list-style-type: none"> <li>secure lever . . . . . 8-7</li> <li>service aids . . . . . 5-2</li> <li>side button 1 . . . . . 6-5</li> <li>side button 2 . . . . . 6-3, 6-5</li> </ul>	<ul style="list-style-type: none"> <li>side button 3 . . . . . 6-3, 6-5</li> <li>softpot . . . . . 7-3</li> <li>submersion time . . . . . 4-3</li> <li>switching regulator . . . . . 9-1</li> </ul>
---	---

## T

---

<ul style="list-style-type: none"> <li>test           <ul style="list-style-type: none"> <li>equipment . . . . . 5-1</li> <li>field . . . . . 5-3</li> </ul> </li> <li>test mode . . . . . 6-3</li> <li>three-position programmable switch . . . . . 6-5</li> </ul>	<ul style="list-style-type: none"> <li>Tone Private-Line . . . . . 6-4</li> <li>top programmable button . . . . . 6-5</li> <li>transmit . . . . . 9-1</li> <li>transmitter key-up . . . . . 6-3</li> <li>two-position concentric switch . . . . . 6-5</li> </ul>
---	--

## U

---

<ul style="list-style-type: none"> <li>universal flex . . . . . 9-1</li> </ul>	<ul style="list-style-type: none"> <li>universal test set . . . . . 7-1</li> </ul>
--	--



**V**

.....

VCO IC . . . . .	9-3	volume control . . . . .	6-5
vocoder board . . . . .	9-3 to 9-4	volume control shaft . . . . .	8-9
Vocoder board . . . . .	9-1	volume insert . . . . .	8-8 to 8-9
vocoler board . . . . .	9-2	volume knob . . . . .	8-8 to 8-9
voltage-controlled oscillator (VCO) . . . . .	9-2		







Motorola, Inc.  
8000 West Sunrise Boulevard  
Ft. Lauderdale, FL 33322

MOTOROLA, the Stylized M Logo, and ASTRO are registered in the U.S. Patent and Trademark Office. All other product or service names are the property of their respective owners.  
© Motorola, Inc. 2004.  
All rights reserved. Printed in U.S.A.



**6881083C85-A**